

ICRealtime Network Video Recorder User's Manual

V 3.1.0

Table of Contents

1	Features and Specifications	1
1.1	Overview.....	1
1.2	Features.....	1
1.3	Specifications.....	2
1.3.1	NVR4i/NVR8i/ NVR4i-P/NVR8i-P Series.....	2
1.3.2	NVR708S2-P/NVR716S2-P/NVR732S2-P Series	3
1.3.3	NVR708X2/NVR716X2/NVR732X2 Series	5
2	Front Panel and Rear Panel.....	8
2.1	Front Panel.....	8
2.1.1	NVR4i/NVR8i/ NVR4i-P/NVR8i-P Series.....	8
2.1.2	NVR708S2-P/NVR716S2-P/NVR732S2-P Series	8
2.1.3	NVR708X2/NVR716X2/NVR732X2 Series	10
2.2	Rear Panel	13
2.2.1	NVR4i/NVR8i/ NVR4i-P/NVR8i-P Series.....	13
2.2.2	NVR708S2-P/NVR716S2-P/NVR732S2-P Series	14
2.2.3	NVR708X2/NVR716X2/NVR732X2 Series	16
2.3	Alarm Connection.....	17
2.4	Bidirectional talk	18
2.4.1	Device-end to PC-end	18
2.4.2	PC-end to the device-end	18
2.5	Mouse Operation.....	19
3	HDD Installation.....	21
3.1	NVR4i/NVR8i/NVR4i-P/NVR8i-P Series.....	21
3.2	NVR708S2-P/ NVR716S2-P/ NVR732S2-P Series	21
3.3	NVR708X2/ NVR716X2/ NVR732X2 Series	22
4	GUI Operation.....	24
4.1	Login.....	24

4.2	Right Click Menu	26
4.3	Main Menu.....	27
4.4	Search & Playback.....	27
4.5	Information	31
4.5.1	HDD Information.....	32
4.5.2	BPS.....	33
4.5.3	Log.....	34
4.5.4	Version	35
4.5.5	Online Users.....	35
4.5.6	Remote Device Information	35
4.5.7	Network Info	36
4.5.7.1	Network Test.....	36
4.5.7.2	Network Load.....	37
4.6	Setting.....	38
4.6.1	General	38
4.6.2	Encode	41
4.6.3	Schedule.....	43
4.6.3.1	Quick Setup.....	44
4.6.4	RS232	44
4.6.5	Network.....	45
4.6.5.1	Network Setting	46
4.6.5.2	IP Filter.....	47
4.6.5.3	NTP Setup.....	48
4.6.5.4	Multicast.....	49
4.6.5.5	PPPoE.....	50
4.6.5.6	DDNS	50
4.6.5.7	UPNP	52
4.6.5.8	WIFI Setting.....	53
4.6.5.9	Email	55
4.6.5.10	FTP.....	56
4.6.5.11	Alarm center.....	58
4.6.5.12	SNMP	58
4.6.5.13	Auto register.....	59
4.6.6	Alarm	60
4.6.7	Detect.....	63
4.6.7.1	Motion Detect.....	64
4.6.7.2	Video Loss.....	66
4.6.7.3	Camera Masking	66
4.6.8	PTZ.....	67
4.6.9	Display	69
4.6.10	Default.....	70

4.6.11	Remote Device	71
4.6.11.1	UPNP	71
4.6.11.2	Built-in Switch Setup	71
4.6.11.3	Remote Device	71
4.6.11.4	Short-cut Menu	74
4.7	Advanced.....	75
4.7.1	HDD Management.....	76
4.7.2	Abnormality.....	78
4.7.3	Alarm Output	79
4.7.4	Manual Record.....	79
4.7.4.1	Manual record menu	80
4.7.4.2	Basic operation	80
4.7.4.3	Enable/disable record	80
4.7.4.4	Enable all channel recording	80
4.7.4.5	Stop all channel recording.....	81
4.7.5	Account	82
4.7.5.1	Modify Password	83
4.7.5.2	Add/Modify Group	83
4.7.5.3	Add/Modify User	84
4.7.6	Auto Maintenance	84
4.7.7	Config Backup.....	85
4.8	Shutdown.....	85
5	Quick Configuration Tool.....	87
5.1	Overview.....	87
5.2	Operation.....	87
6	Web Operation.....	90
6.1	General Introduction	90
6.1.1	Preparation	90
6.1.2	Log in.....	91
6.2	LAN Mode.....	92
6.2.1	Monitor Channel Menu Tree	93
6.2.2	System Menu	96
6.2.3	Monitor Window Switch	96
6.2.4	PTZ Control	96
6.2.5	Color and More Setup.....	98
6.3	WAN Login	99

6.4	Configuration.....	101
6.4.1	System Information	101
6.4.1.1	Version Information	101
6.4.1.2	HDD information	102
6.4.1.3	Log.....	102
6.4.2	System Configuration	103
6.4.2.1	General Setup.....	103
6.4.2.2	Encode	105
6.4.2.3	Schedule.....	106
6.4.2.4	RS232	108
6.4.2.5	Network.....	109
6.4.2.6	Alarm	117
6.4.2.1	Detect.....	119
6.4.2.2	PTZ.....	121
6.4.2.3	Default & Backup.....	122
6.4.3	Advanced.....	123
6.4.3.1	HDD Management	123
6.4.3.2	Abnormity.....	124
6.4.3.3	Alarm I/O.....	125
6.4.3.4	Record.....	126
6.4.3.5	Account	126
6.4.3.6	Snapshot.....	128
6.4.3.7	Auto Maintenance	128
6.4.3.8	Remote device	129
6.4.3.9	Preview Control.....	130
6.4.4	Additional Function.....	131
6.4.4.1	IPC Config	131
6.4.4.2	Auto register	133
6.4.4.3	Mobile Config	133
6.4.4.4	WIFI Config	134
6.5	Search.....	135
6.6	Alarm.....	138
6.7	About.....	140
6.8	Log out.....	140
7	FAQ.....	141
8	Appendix A HDD Capacity Calculation	146
9	Appendix B Compatible SATA HDD	147

10	Appendix C Compatible USB2.0 List	152
11	Appendix D Compatible Displayer List.....	154
	Appendix H Toxic or Hazardous Materials or Elements.....	155

Welcome

Thank you for purchasing our network video recorder!

This user's manual is designed to be a reference tool for your system.

Please open the accessory bag to check the items one by one in accordance with the list below.

Contact your local retailer ASAP if something is missing or damaged in the bag.

Important Safeguards and Warnings

1 . Electrical safety

All installation and operation here should conform to your local electrical safety codes. We assume no liability or responsibility for all the fires or electrical shock caused by improper handling or installation.

2 . Transportation security

Heavy stress, violent vibration or water splash are not allowed during transportation, storage and installation.

3 . Installation

Keep upwards. Handle with care.

Do not apply power to the NVR before completing installation.

Do not place objects on the NVR

4 . Qualified engineers needed

All the examination and repair work should be done by the qualified service engineers.

We are not liable for any problems caused by unauthorized modifications or attempted repair.

5 . Environment

The NVR should be installed in a cool, dry place away from direct sunlight, inflammable, explosive substances and etc.

This series product shall be transported, storage and used in the specified environments.

6. Accessories

Be sure to use all the accessories recommended by manufacturer.

Before installation, please open the package and check all the components are included.

Contact your local retailer ASAP if something is broken in your package.

7. Lithium battery

Improper battery use may result in fire, explosion, or personal injury!

When replace the battery, please make sure you are using the same model!

Before your operation please read the following instructions carefully.

- **Installation environment**

- ✧ Keep away from extreme hot places and sources;
- ✧ Avoid direct sunlight;
- ✧ Keep away from extreme humid places;
- ✧ Avoid violent vibration;
- ✧ Do not put other devices on the top of the NVR;
- ✧ Be installed in well ventilated place; do not block the vent.

- **Accessories**

Check the following accessories after opening the box:

- **Please refer to the packing list in the box ***

1 Features and Specifications

1.1 Overview

This series NVR is a high performance network video recorder. This series product support local preview, multiple-window display, recorded file local storage, remote control and mouse shortcut menu operation, and remote management and control function.

This series product supports centre storage, front-end storage and client-end storage. The monitor zone in the front-end can be set in anywhere. Working with other front-end devices such as IPC, NVS, this series product can establish a strong surveillance network via the CMS. In the network system, there is only one network cable from the monitor centre to the monitor zone in the whole network. There is no audio/video cable from the monitor centre to the monitor zone. The whole project is featuring of simple connection, low-cost, low maintenance work.

This series NVR can be widely used in many areas such as public security, water conservancy, transportation and education.

1.2 Features

User Management	<ul style="list-style-type: none">• Each group has different management powers that can be edited freely. Every user belongs to an exclusive group.
Storage	<ul style="list-style-type: none">• Via corresponding setup (such as alarm setup and schedule setup), you can backup related audio/video data in the network video recorder.• Support Web record and record local video and storage the file in the client end.
Alarm	<ul style="list-style-type: none">• Respond to external alarm simultaneously (within 200MS), based on user's pre-defined relay setup, system can process the alarm input correctly and prompt user by screen and voice (support pre-recorded audio).• Support central alarm server setup, so that alarm information can remotely notify user automatically. Alarm input can be derived from various connected peripheral devices.• Alert you via EMAIL.
Network Monitor	<ul style="list-style-type: none">• Through network, sending audio/video data compressed by IPC or NVS to client-ends, then the data will be decompressed and display. If bandwidth is big enough, latency is less than 500ms• Support max 10 connections• Transmit audio/video data by HTTP, TCP, UDP, MULTICAST, RTP/RTCP and etc.• Transmit some alarm data or alarm info by SMTP.• Support WEB access in WAN.
Window Split	<ul style="list-style-type: none">• Adopt the video compression and digital process to show several windows in one monitor. Support 1/4/8/9/16-window display.
Record	<ul style="list-style-type: none">• Support schedule record function. Save the recorded files in the HDD, client-end PC, or network storage server. You can search or playback the saved files at the local-end or via the Web.

Backup	<ul style="list-style-type: none"> Support network backup, USB2.0 record backup function, the recorded files can be saved in network storage server, peripheral USB2.0 device, burner and etc.
Network Management	<ul style="list-style-type: none"> Supervise NVR configuration and control power via Ethernet. Support management via WEB.
Peripheral Equipment Management	<ul style="list-style-type: none"> Support peripheral equipment management such as protocol setup and port connection. Support transparent data transmission such as RS232 (RS-422), RS485 (RS-485).
Auxiliary	<ul style="list-style-type: none"> Support switch between NTSC and PAL. Support real-time system resources information and running statistics display. Support log file. Local GUI output. Shortcut menu operation via mouse. IR control function. Shortcut menu operation via remote control. Support IPC or NVS remote video preview and control.

1.3 Specifications

1.3.1 NVR4i/NVR8i/ NVR4i-P/NVR8i-P Series

Parameter	Specifications	
	NVR4i/NVR8i	NVR4i-P/NVR8i-P
System Resources	Max support 16-ch standard definition with the transmission rate of 2Mbps for each channel; 8-channel 720P, with the transmission rate of 4Mbps for each channel; 4-channel 1080P, with the transmission rate of 8Mbps for each channel; Support 20 online users at the same time, The image delay time of each channel is under 500ms.	
Operation System	Embedded Linux real-time operation system	
Operation Interface	WEB/Local GUI	
Video Compression	H.264/MPEG4	
Encode Capacity	For H.264, it max supports 16-channel D1, 8-channel 720P, 4-channel 1080P.	
Audio Compression	G.711a	
Video Output	1-channel VGA analog video output.	
Video Input	4/8/16-ch network compression video input	
HDMI	1-ch HDMI output.	
Audio Input	1-ch bidirectional audio input	
Audio Output	N/A	

Wireless AP antenna	N/A	
Window Split	1/4/9-window	
Multiple-channel Playback	Max 16-channel D1/8-channel 720P/4-channel 1080P playback.	
Alarm Input	N/A	
Alarm Output	N/A	
Storage	One built-in SATA port.	
RS232 Port	N/A	
RS485 port	N/A	
USB2.0 Port	One peripheral USB2.0 port.	
Network Connection	One RJ45 10/100Mbps self-adaptive Ethernet port.	
Power Port	One power port, power adapter. Input DC 12V.	Two power ports, power adapter. Input DC 12V or DC 48V.
Power Button	No on/off button. Connect to the power cable to boot up.	
Power Button	N/A	
IR Remote Control Receiver	Support IR remote control	
Clock	Built-in clock.	
Indication Light	One power status indication light. One network status indication light. One HDD status indication light.	
Power Consumption	<12W(Exclude HDD)	
Working Temperature	0℃~+50℃	
Working Humidity	10%—90%	
Air pressure	86kpa—106kpa	
Dimension	270mmX205mmX41mm	
Weight	600-700G (Exclude HDD)	
Installation	Desk installation	

1.3.2 NVR708S2-P/NVR716S2-P/NVR732S2-P Series

Parameter	Specifications
	NVR708S2-P/NVR716S2-P/NVR732S2-P
System Resources	Max support 32-ch standard definition with the transmission rate of 2Mbps for each channel; 16-channel 720P, with the transmission rate of 4Mbps for each channel; 8-channel 1080P, with the transmission rate of 8Mbps for each channel; Support 20 online users at the same time, The image delay time of each channel is under 500ms.
Operation System	Embedded Linux real-time operation system
Operation Interface	WEB/Local GUI
Video Compression	H.264/MPEG4
Encode Capacity	For H.264, it max supports 32*D1,16*720,8*1080P
Audio Compression	G.711a
Video Output	1-channel VGA analog video output.
Video Input	4/8/16/32-ch network compression video input
HDMI	1-ch HDMI output.
Audio Input	1-ch bidirectional audio input
Audio Output	1-ch bidirectional talk output.
Window Split	1/4/8/9/16/25/36-window
Multiple-channel Playback	Max 16-channel playback.
Alarm Input	8-ch alarm input
Alarm Output	3-ch alarm output
	Relay output. Relay (DC 30V 1A, AC 125V 0.5A (Activation output)) Including one controllable DC +12V output.
Storage	2 built-in SATA ports.
RS232 Port (RS-422)	One RS232 port to debug transparent COM data.
RS485 port (RS-485)	One RS485 port to control PTZ. Support various protocols.
USB2.0 Port	2 peripheral USB2.0 ports.
Network Connection	One RJ45 10/100M/1000Mbps self-adaptive Ethernet port.
Power Port	Two power ports, power adapter. Input DC 12V or DC 48V.

Power Button	One power button in the rear panel.
Power Button	One power button in the front panel.
IR Remote Control Receiver	Support IR remote control
Clock	Built-in clock.
Indication Light	<ul style="list-style-type: none"> ● 16 record status indication lights ● One power status indication light. ● One alarm status indication light. ● One network status indication light. ● One HDD status indication light.
Power Consumption	<12W(Exclude HDD)
Working Temperature	0℃~+50℃
Working Humidity	10%—90%
Air pressure	86kpa—106kpa
Dimension	375mm×287mm×52mm
Weight	1.5~2.5 KG (Exclude HDD)
Installation	Desk installation

1.3.3 NVR708X2/NVR716X2/NVR732X2 Series

Parameter	Specifications
	NVR708X2/NVR716X2/NVR732X2
System Resources	Max support 32-ch standard definition with the transmission rate of 2Mbps for each channel; 16-channel 720P, with the transmission rate of 4Mbps for each channel; 8-channel 1080P, with the transmission rate of 8Mbps for each channel; Support 20 online users at the same time, The image delay time of each channel is under 500ms.
Operation System	Embedded Linux real-time operation system
Operation Interface	WEB/Local GUI
Video Compression	H.264/MPEG4
Encode Capacity	For H.264, it max supports 32-channel D1,16-channel 720P,8-channel 1080P
Audio Compression	G.711a
Video Output	1-channel VGA analog video output.

Video Input	8/16/32-ch network compression video input
HDMI	1-ch HDMI output.
Audio Input	1-ch bidirectional audio input
Audio Output	1-ch bidirectional talk output.
Window Split	1/4/8/9/16/25/36-window
Multiple-channel Playback	Max 16-channel playback.
Alarm Input	16-ch alarm input
Alarm Output	6-ch alarm output
	Relay output. Relay (DC 30V 1A, AC 125V 0.5A (Activation output)) Including one controllable DC +12V output.
Storage	8 built-in SATA ports.
	1 peripheral eSATA port
RS232 Port (RS-422)	One RS232 port to debug transparent COM data.
RS485 port (RS-485)	One RS485 port to control PTZ. Support various protocols.
USB2.0 Port	4 peripheral USB2.0 ports.
Network Connection	Two RJ45 10/100M/1000Mbps self-adaptive Ethernet ports.
Power Port	One power port. AC100-240V, 50-60Hz, 1.9A.
Power Button	One power button in the rear panel.
Power Button	One power button in the front panel.
IR Remote Control Receiver	Support IR remote control
Clock	Built-in clock.
Indication Light	<ul style="list-style-type: none"> ● 16 record status indication lights ● One system running status indication light. ● One remote control button indication light.
Power Consumption	<40W(Exclude HDD)
Working Temperature	0℃~+50℃
Working Humidity	10%—90%
Air pressure	86kpa—106kpa
Dimension	440mm×460mm×89mm

Weight	5.5~6.5 KG (Exclude HDD)
Installation	Desk installation

2 Front Panel and Rear Panel

2.1 Front Panel

2.1.1 NVR4i/NVR8i/ NVR4i-P/NVR8i-P Series

The front panel is shown as in Figure 2-1.

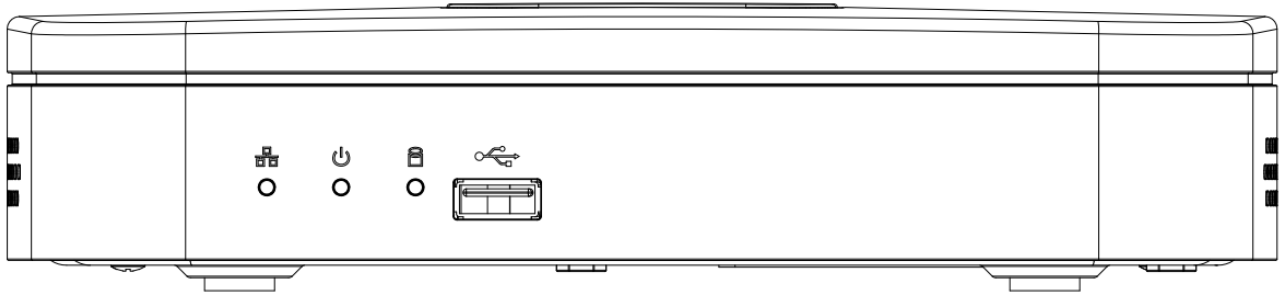

Figure 2-1

Please refer to the following sheet for detailed information.

Icon	Name	Function
	Power indicator light	The blue light becomes on when the power connection is OK.
	Network status indicator light	The blue light becomes on when the network connection is abnormal or offline.
	HDD status indicator light	The red light becomes on when HDD is abnormal or HDD space is below the threshold.
	USB	USB port. Connect to USB storage device, mouse burner and etc.

2.1.2 NVR708S2-P/NVR716S2-P/NVR732S2-P Series

The front panel is shown as in Figure 2-2.

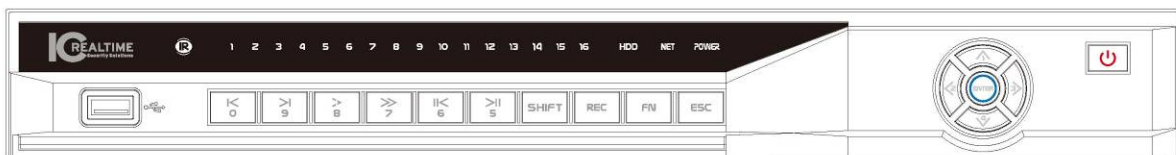

Figure 2-2

Please refer to the following sheet for detailed information.

Name	Icon	Function
Power button		Power button, press this button for three seconds to boot up or shut down DVR.

Shift	Shift	In textbox, click this button to switch between numeral, English(Small/Capitalized),donation and etc.
Up/1 Down/4	▲、▼	Activate current control, modify setup, and then move up and down.
		Increase/decrease numeral.
		Assistant function such as PTZ menu.
		In text mode, input number 1/4 (English character G/H/I)
Left/2 Right/3	◀ ▶	Shift current activated control,
		When playback, click these buttons to control playback bar. In text mode, input number 2(English character A/B/C) /3(English character D/E/F)
ESC	ESC	Go to previous menu, or cancel current operation.
		When playback, click it to restore real-time monitor mode.
Enter	ENTER	Confirm current operation
		Go to default button
		Go to menu
Record	REC	Manually stop/start recording, working with direction keys or numeral keys to select the recording channel.
Slow play/8	▶	Multiple slow play speeds or normal playback. In text mode, input number 8 (English character T/U/V).
Assistant	Fn	One-window monitor mode, click this button to display assistant function: PTZ control and image color.
		Backspace function: in numeral control or text control, press it for 1.5seconds to delete the previous character before the cursor.
		In motion detection setup, working with Fn and direction keys to realize setup.
		In text mode, click it to switch between numeral, English character(small/capitalized) and etc.
		Realize other special functions.
Fast play/7	▶▶	Various fast speeds and normal playback. In text mode, input number 7 (English character P/Q/R/S).
Play previous/0	⏮	In playback mode, playback the previous video In text mode, input number 0.

Reverse/Pause/6	⏮	In normal playback or pause mode, click this button to reverse playback In reverse playback, click this button to pause playback.
Play Next/9	⏭	In playback mode, playback the next video In menu setup, go to down ward of the dropdown list. In text mode, input number 9 (English character W/X/Y/Z)
Play/Pause /5	⏸	In normal playback click this button to pause playback In pause mode, click this button to resume playback. In text mode, input number 5(English character J/K/L).
USB port	🔌	To connect USB storage device, USB mouse.
Network abnormal indication light	Net	Network error occurs or there is no network connection, the light becomes red to alert you.
HDD abnormal indication light	HDD	HDD error occurs or HDD capacity is below specified threshold value, the light becomes red to alert you.
Record light	1-16	System is recording or not. It becomes on when system is recording.
IR Receiver	IR	It is to receive the signal from the remote control.
Alarm indication light	Alarm	Here you can view there is external alarm input or not. The light becomes on when there is an external alarm. The light become off when the external alarm stops.

2.1.3 NVR708X2/NVR716X2/NVR732X2 Series

The front panel is shown as in Figure 2-3.





Figure 2-3

Please refer to the following sheet for front panel button information.

Name	Icon	Function
Power button	🔌	Power button, press this button for three seconds to boot up or shut down DVR.

Number and Character	0	In text mode, input number 0. It is the space button.
	1,.	In text mode, input number 1 and denotation.
	2ABC	In text mode, input number 2(English character A/B/C)
	3DEF	In text mode, input number 3(English character D/E/F)
	4GHI	In text mode, input number 4 (English character G/H/I)
	5JKL	In text mode, input number 5(English character J/K/L).
	6MNO	In text mode, input number 6 (English character M/N/O)
	7PQRS	In text mode, input number 7 (English character P/Q/R/S).
	8TUV	In text mode, input number 8 (English character T/U/V).
	9WXYZ	In text mode, input number 9 (English character W/X/Y/Z)
	-/--	If you want to input a number more than 10, please click this button and then input.
Shift	↑	In textbox, click this button to switch between numeral, English(Small/Capitalized),donation and etc.
Up Down	▲、▼	Activate current control, modify setup, and then move up and down.
		Increase/decrease numeral.
		Assistant function such as PTZ menu.
Left Right	◀ ▶	Shift current activated control,
		When playback, click these buttons to control playback bar.
ESC	ESC	Go to previous menu, or cancel current operation.
		When playback, click it to restore real-time monitor mode.
Enter	ENTER	Confirm current operation
		Go to default button
		Go to menu
Record	REC	Manually stop/start recording, working with direction keys or numeral keys to select the recording channel.
Window switch	Mult	Click it to switch one-window/multiple-window.
Slow play/8	▶	Multiple slow play speeds or normal playback.
Assistant	Fn	One-window monitor mode, click this button to display assistant function: PTZ control and image color.

		<p>Backspace function: in numeral control or text control, press it for 1.5seconds to delete the previous character before the cursor.</p> <p>In motion detection setup, working with Fn and direction keys to realize setup.</p> <p>In text mode, click it to switch between numeral, English character(small/capitalized) and etc.</p> <p>Realize other special functions.</p>
Fast play	▶▶	Various fast speeds and normal playback.
Play previous	◀	In playback mode, playback the previous video
Reverse/Pause	◀	<p>In normal playback or pause mode, click this button to reverse playback</p> <p>In reverse playback, click this button to pause playback.</p>
Play Next	▶	<p>In playback mode, playback the next video</p> <p>In menu setup, go to down ward of the dropdown list.</p>
Play/Pause	▶	<p>In normal playback click this button to pause playback</p> <p>In pause mode, click this button to resume playback.</p>
USB port		To connect USB storage device, USB mouse.
Status indication light	Status	If there is Fn indication light, current status indication light is null.
HDD abnormal	HDD	HDD error occurs or HDD capacity is below specified threshold value, the light becomes red to alert you.
Remote control indication light	ACT	Remote control indication light
Power indication light	Power	Power indication light
Record light	1-16	<p>System is recording or not. It becomes on when system is recording.</p> <p>For this series product, the last 12 lights are null since there is only four channels.</p>

IR Receiver	IR	It is to receive the signal from the remote control.
Shuttle(outer ring)		In real-time monitor mode it works as left/right direction key. Playback mode, counter clockwise to forward and clock wise to backward.
Jog(inner dial)		Up/down direction key. Playback mode, turn the inner dial to realized frame by frame playback. (Only applies to some special versions.)
CD-ROM button		Pop-up or insert the CD.

2.2 Rear Panel

2.2.1 NVR4i/NVR8i/ NVR4i-P/NVR8i-P Series

The NVR4i/NVR8i series rear panel is shown as below. See Figure 2-4.

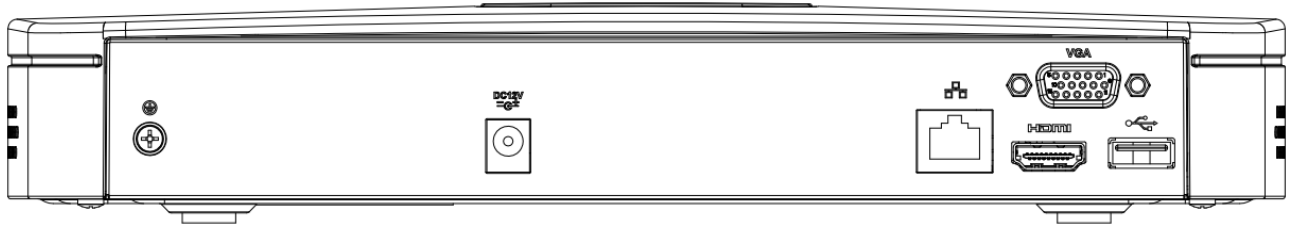

Figure 2-4

The NVR4i-P/ NVR8i-P series rear panel is shown as below. See Figure 2-5.

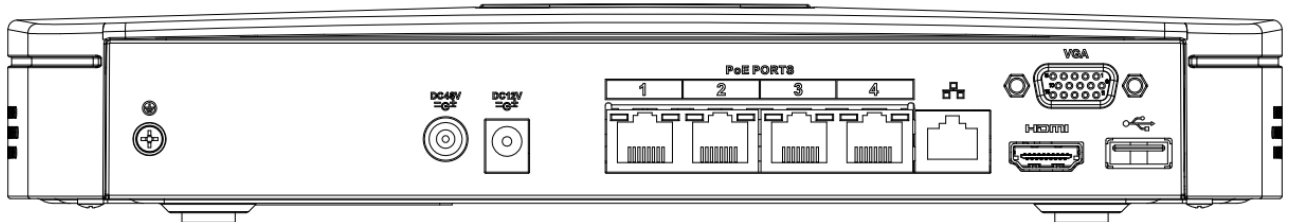







Figure 2-5

Please refer to the following sheet for detailed information.

Port Name		Connection	Function
	Network port	/	10M/100/1000Mbps self-adaptive Ethernet port. Connect to the network cable.
HDMI	High Definition Media Interface	/	High definition audio and video signal output port. It transmits uncompressed high definition video and multiple-channel data to the HDMI port of the display device.

Port Name		Connection	Function
VGA	VGA video output port	VGA	VGA video output port. Output analog video signal. It can connect to the monitor to view analog video.
	GND	/	Alarm input port GND port.
	Power input port	/	Power port. Input 12V DC.
	Power input port	/	Switch power port. Input DC 48V.
PoE PORTS	4 PoE ports	/	Built-in Switch supports PoE function. The 4 PoE ports series product supports total 48V 50W.
	USB 2.0 port	/	USB 2.0 port. Conenct to mouse.
Wireless AP			Support wireless hotspot function. Use WIFI to connect to the network camera when there is a hotspot.

2.2.2 NVR708S2-P/NVR716S2-P/NVR732S2-P Series

The rear panel is shown as below. See Figure 2-6.

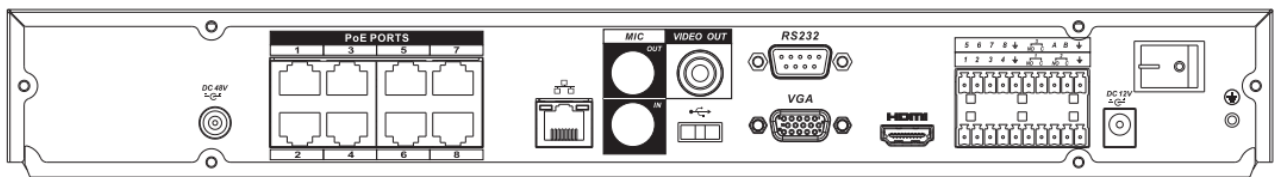





Figure 2-6

Please refer to the following sheet for detailed information.

	Port Name	Connection	Function
USB2.0	USB2.0 port.	/	Connect to USB2.0 mouse.
	Network port	/	10M/100M/1000Mbps self-adaptive Ethernet port. Connect to the network cable.
RS232	RS232 debug COM.	/	It is for general COM debug to configure IP address or transfer transparent COM data.
HDMI	High Definition Media Interface	/	High definition audio and video signal output port. It transmits uncompressed high definition video and multiple-channel data to the HDMI port of the display device.
VGA	VGA video output port	VGA	VGA video output port. Output analog video signal. It can connect to the monitor to view analog video.

	Port Name	Connection	Function
1-8	Alarm input port 1-8.	I/O port	<ul style="list-style-type: none"> There are two groups. The first group is from port 1 to port 4; the second group is from port 5 to port 8. They are to receive the signal from the external alarm source. There are two types; NO (normal open)/NC (normal close). When your alarm input device is using external power, please make sure the device and the NVR have the same ground.
	Alarm input port ground end		Alarm input ground end.
NO1~NO3	Alarm output port 1~3		<ul style="list-style-type: none"> 3 groups of alarm output ports. (Group 1: port NO1~C1, Group 2: port NO2~C2, Group 3: port NO3~C3). Output alarm signal to the alarm device. Please make sure there is power to the external alarm device. NO: Normal open alarm output port. C: Alarm output public end.
C1~C3			
A	RS485 (RS-485) communication port		RS485_A port. It is the cable A. You can connect to the control devices such as speed dome PTZ.
B			RS485_B. It is the cable B. You can connect to the control devices such as speed dome PTZ.
	Power input port	/	Input 12V DC.
Power button	/	/	Power on/off button.
PoE PORTS	8 PoE ports	/	Built-in Switch supports PoE function. The 8 PoE ports series product supports total 48V 120W.
	Power input port	/	Switch power port. Input DC 48V.
VIDEO OUT	Video input port	/	CVBS output
MIC IN	Audio input port	/	Bidirectional talk input port. It is to receive the analog audio signal output from the devices such as mike phone, pickup.

	Port Name	Connection	Function	
	MIC OUT	Audio output port	/	<p>Audio output port. It is to output the analog audio signal to the devices such as the sound box.</p> <ul style="list-style-type: none"> ● Bidirectional talk output. ● Audio output on 1-window video monitor. ● Audio output on 1-window video playback.

2.2.3 NVR708X2/NVR716X2/NVR732X2 Series

The rear panel is shown as below. See Figure 2-7.

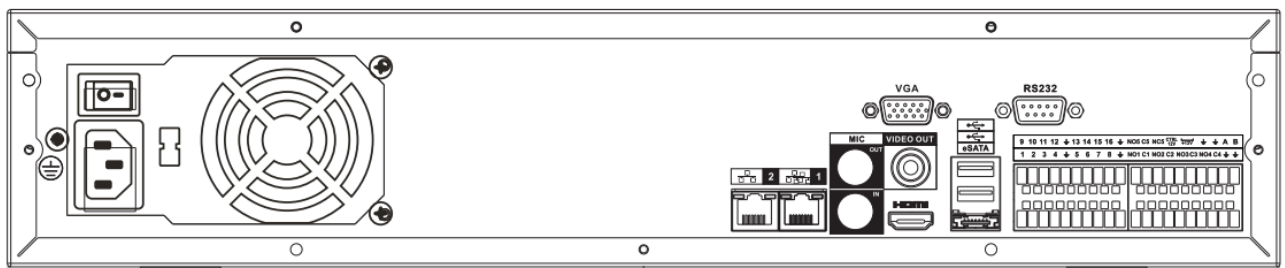



Figure 2-7

Please refer to the following sheet for detailed information.

Port Name	Connection	Function
Power button	/	Power on/off button.
Power input port	/	Input AC 220V power.
MIC IN	Audio input port	Bidirectional talk input port. It is to receive the analog audio signal output from the devices such as mike phone, pickup.
MIC OUT	Audio output port	Audio output port. It is to output the analog audio signal to the devices such as the sound box.
1-16	Alarm input port 1-16.	<ul style="list-style-type: none"> ● There are four groups. The first group is from port 1 to port 4, the second group is from port 5 to port 8, the third group is from 9 to 12, and the fourth group is from 13 to 16. They are to receive the signal from the external alarm source. There are two types; NO (normal open)/NC (normal close). ● When your alarm input device is using external power, please make sure the device and the NVR have the same ground.
	Ground end	Alarm input ground end.
NO1 to NO5	5-ch alarm output port	<ul style="list-style-type: none"> ● 5 groups of alarm output ports. (Group 1: port NO1~C1, Group 2: port NO2~

Port Name		Connection	Function
C1 to C5			C2, Group 3: port NO3~C3, Group 4: port NO4~C4, Group 5: port NO5, C5, NC5). Output alarm signal to the alarm device. Please make sure there is power to the external alarm device. <ul style="list-style-type: none"> • NO: Normal open alarm output port. • C: Alarm output public end. • NC: Normal close alarm output port.
NC5			
A	RS485 (RS-485) communication port		
B			RS485_B. It is the cable B. You can connect to the control devices such as speed dome PTZ.
CTRL 12V	/	/	Controller 12V power output. It is to control the on-off alarm relay output. It can be used to control the device alarm output. At the same time, it can also be used as the power input source of some devices such as the alarm detector.
+12V	/	/	+12V power output port. It can provide the power to some peripheral devices such as the camera or the alarm device. Please note the supplying power shall be below 1A.
	Network port	/	Two 10M/100M/1000M self-adaptive Ethernet ports. Connect to the network cable.
eSATA	eSATA port	/	External SATA port. It can connect to the device of the SATA port. Please jump the HDD when there is peripheral connected HDD.
	USB port.		Connect to USB mouse.
RS232(RS-422)	RS232 debug COM.		It is for general COM debug to configure IP address or transfer transparent COM data.
HDMI	High Definition Media Interface		High definition audio and video signal output port. It transmits uncompressed high definition video and multiple-channel data to the HDMI port of the display device.
VGA	VGA video output port		VGA video output port. Output analog video signal. It can connect to the monitor to view analog video.

2.3 Alarm Connection

Please refer to the steps listed below.

- Connect the alarm input device to the alarm input port.
- Connect the alarm output device to the alarm output port. The NO and NC alarm output

device can connect to the NO/C/NC port. For the NO alarm device, please connect to the NO/C ports. For the NC alarm device, please connect to the NC/C ports. Please note the NO/C ports are for NO alarm device only.

- Open Web, and go to the Alarm setup interface to set the alarm input and output. The alarm 01 is corresponding to the first channel of the device I/O port and so on. Please set the NO/NC type according to the high/low level the alarm input device generated when an alarm occurred
- Set the alarm output on the Web. The alarm output 01 is corresponding to the first group of alarm out put port.

2.4 Bidirectional talk

2.4.1 Device-end to PC-end

Device Connection

Please connect the speaker or the pickup to the first audio input port in the device rear panel. Then connect the earphone or the sound box to the audio output port in the PC.

Login the Web and then enable the corresponding channel real-time monitor.

Please refer to the following interface to enable bidirectional talk. See Figure 2-8.



Figure 2-8

Listening Operation

At the device end, speak via the speaker or the pickup, and then you can get the audio from the earphone or sound box at the pc-end. See Figure 2-9.

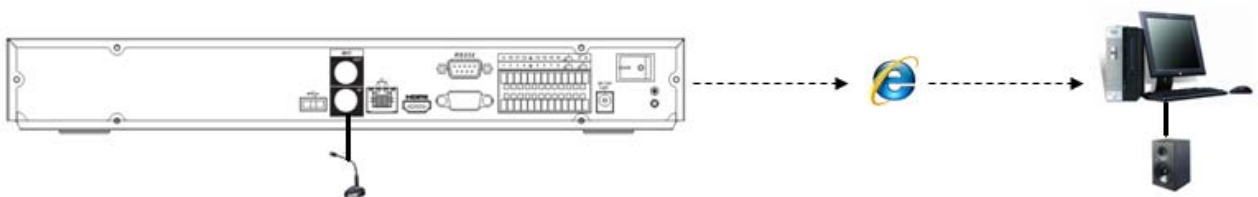

Figure 2-9

2.4.2 PC-end to the device-end

Device Connection

Connect the speaker or the pickup to the audio output port in the PC and then connect the earphone or the sound box to the first audio input port in the device rear panel.

Login the Web and then enable the corresponding channel real-time monitor.

Please refer to the above interface (Figure 2-8) to enable bidirectional talk.

Listening Operation

At the PC-end, speak via the speaker or the pickup, and then you can get the audio from the earphone or sound box at the device-end. See Figure 2-10.

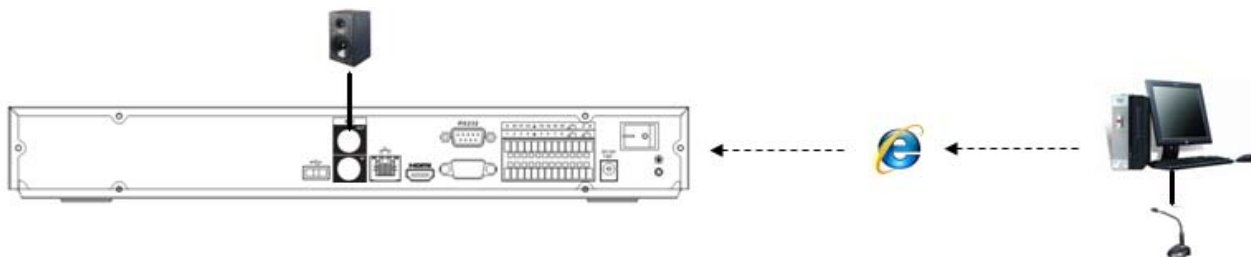

Figure 2-10

2.5 Mouse Operation

Please refer to the following sheet for mouse operation instruction.

Left click mouse	When you have selected one menu item, left click mouse to view menu content.
	Modify checkbox or motion detection status.
	Click combo box to pop up dropdown list
	In input box, you can select input methods. Left click the corresponding button on the panel you can input numeral/English character (small/capitalized). Here ← stands for backspace button. _ stands for space button.
	In English input mode: _stands for input a backspace icon and ← stands for deleting the previous character.
	In numeral input mode: _ stands for clear and ← stands for deleting the previous numeral.
Double left click mouse	Implement special control operation such as double click one item in the file list to playback the video.
	In multiple-window mode, double left click one channel to view in full-window. Double left click current video again to go back to previous multiple-window mode.

Right click mouse	In real-time monitor mode, pops up shortcut menu.
	Exit current menu without saving the modification.
Press middle button	In numeral input box: Increase or decrease numeral value.
	Switch the items in the check box.
	Page up or page down
Move mouse	Select current control or move control
Drag mouse	Select motion detection zone
	Select privacy mask zone.

3 HDD Installation

Important:

Please turn off the power before you replace the HDD.

The pictures listed below for reference only.

For the first time install, please be aware that whether the HDDs have been installed. You can refer to the Appendix for recommended HDD brand. Please use HDD of 7200rpm or higher. Usually we do not recommend the PC HDD. Please follow the instructions below to install hard disk.

3.1 NVR4i/NVR8i/NVR4i-P/NVR8i-P Series



1. Loosen the screws of the upper cover and side panel.	2. Fix four screws in the HDD (Turn just three rounds).	3. Place the HDD in accordance with the four holes in the bottom.
---	---	---

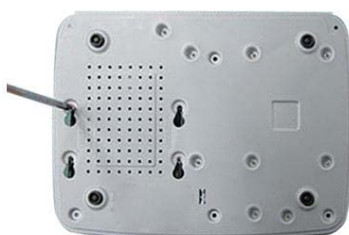

4. Turn the device upside down and then turn the screws in firmly.	5. Fix the HDD firmly.	6. Connect the HDD cable and power cable.
--	------------------------	---



7. Put the cover in accordance with the clip and then place the upper cover back.	8. Secure the screws in the rear panel and the side panel.
---	--

3.2 NVR708S2-P/ NVR716S2-P/ NVR732S2-P Series



1. Loosen the screws of the upper cover and side panel.

2. Fix four screws in the HDD (Turn just three rounds).

3. Place the HDD in accordance with the four holes in the bottom.



4. Turn the device upside down and then turn the screws in firmly.

5. Fix the HDD firmly.

6. Connect the HDD cable and power cable.



7. Put the cover in accordance with the clip and then place the upper cover back.

8. Secure the screws in the rear panel and the side panel.

3.3 NVR708X2/ NVR716X2/ NVR732X2 Series



① Use the screwdriver to loose the screws of the rear panel and then remove the front cover.



- ② Put the HDD to the HDD bracket in the chassis and then line up the four screws to the four holes in the HDD. Use the screwdriver to fix the screws firmly to secure HDD on the HDD bracket



- ③ Connect to the HDD data cable to the main board and the HDD port respectively. Loosen the power cable of the chassis and connect another end of the power cable to the HDD port.



- ④ After connect the cable, put the front cover back to the device and then fix screws of the rear panel.

4 GUI Operation

Connect the device to the monitor and then connect a mouse and power cable. Click the power button at the rear panel and then boot up the device to view the video output. You can use the mouse to implement some GUI operation.

4.1 Login

After device booted up, the system is in multiple-channel display mode. See Figure 4-1. Please note the displayed window amount may vary. The following figure is for reference only.

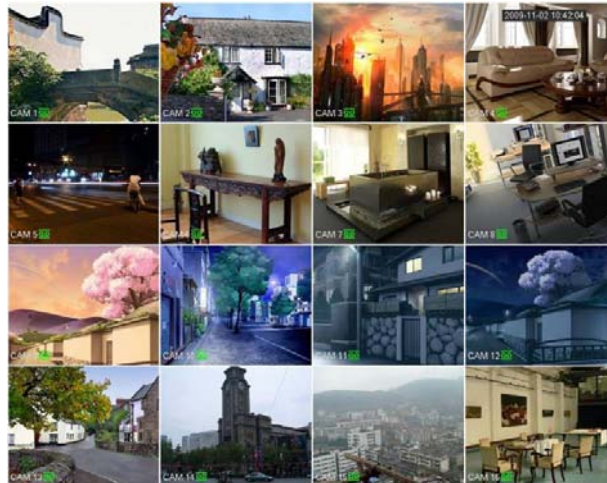

Figure 4-1

System consists of four accounts:

- **Username:** admin. **Password:** admin. (administrator, local and network)
- **Username:** 888888. **Password:** 888888. (administrator, local only)
- **Username:** 666666. **Password:** 666666 (Lower authority user who can only monitor, playback, backup and etc.)
- **Username:** default. **Password:** default(hidden user)

You can use USB2.0 mouse to input. Click **123** to switch between numeral, English character (small/capitalized) and denotation.

Note:

For security reason, please modify password after you first login.

Within 30 minutes, three times login failure will result in system alarm and five times login failure will result in account lock!

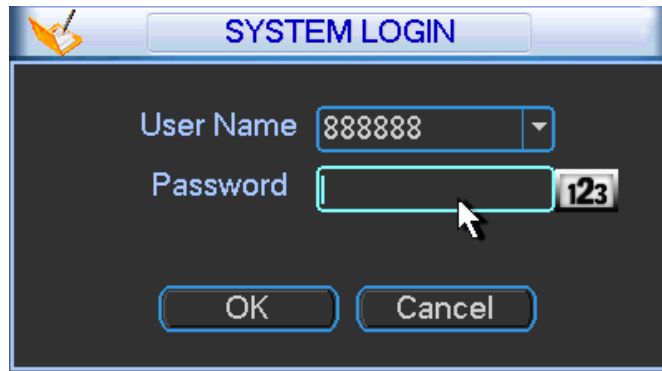

Figure 4-2

You can overlay the corresponding date, time and channel name on each screen. You can refer to the following sheet for channel record or alarm status information.

1		Recording status	3		Video loss
2		Motion detection	4		Camera lock

Preview Control

The preview control function has the following features.

- Support preview playback.
 - ✧ In the preview desktop, system can playback previous 5-60 minutes record of current channel. Please go to the Main Menu->General to set real-time playback time.
 - ✧ Support drag and play function. You can use your mouse to select any playback start time.
 - ✧ Support playback, pause and exit function.
 - ✧ Right now, system does not support slow playback and backward playback function.
- Support digital zoom function.
- Support real-time backup function.

You can follow the contents listed below for the operation instruction.

Preview control interface

Move your mouse to the top centre of the video of current channel, you can see system pops up the preview control interface. See Figure 4-3. If your mouse stays in this area for more than 6 seconds and has no operation, the control bar automatically hides.

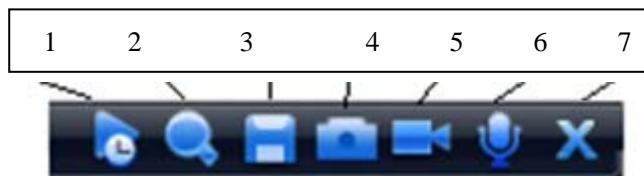







Figure 4-3

You can refer to the following sheet for detailed information.

SN	Name	Function
1	Realtime playback	It is to playback the previous 5-60 minutes record of current channel. Please go to the Main Menu->General to set

		real-time playback time. System may pop up a dialogue box if there is no such record in current channel.
2	Digital zoom	It is to zoom in specified zone of current channel. It supports zoom in function of multiple-channel. The selected area has an icon as  and the free area is shown as an icon as  .
3	Real-time backup function	It is to backup the video of current channel to the USB2.0 device. System can not backup the video of multiple-channel at the same time. Current selected backup channel has an icon as  and the free channel is shown as an icon as  Once the backup started, you can see the free channel is shown as an icon as  .
4	Manual Snap	Click it to snap manually.
5	Remote device add shortcut	It is to go to the remote device connection interface.
6	Bidirectional talk	Support bidirectional talk function with the front-end device.
7		Exit

Playback control

The playback control has the following features.

- Support play, pause, and exit and drag function.
- During the preview playback process, you can not see the channel title and record status of current channel. It will display the channel title and the record status once you exit the preview playback.
- During the preview playback, you can not switch the displayed channel or change current window-display mode.
- Please note, the tour function has the higher priority than the preview playback. System automatically exits the preview playback function and its corresponding interface when the tour function started. You can not control the preview playback until the tour function ended.

4.2 Right Click Menu

After you logged in the device, right click mouse, you can see the short cut menu. Please see Figure 4-4.

Here you can set local playback window, PTZ control, video color, search records, remote device and etc. The local playback window includes 1/4/8/9/16. You can set the detail channel amount in 1/4-window.

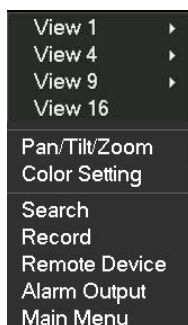

Figure 4-4

4.3 Main Menu

After you logged in, the system main menu is shown as below. See Figure 4-5. There are total seven icons: search, Information, setting, remote device, backup, advanced and shutdown. Move the cursor to highlight the icon, then double click mouse to enter the sub-menu.

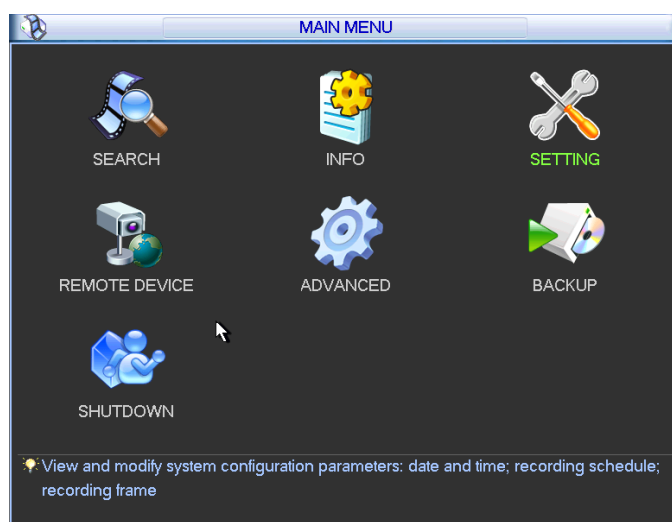

Figure 4-5

4.4 Search & Playback

Click search button in the main menu, search interface is shown as below. See Figure 4-6.

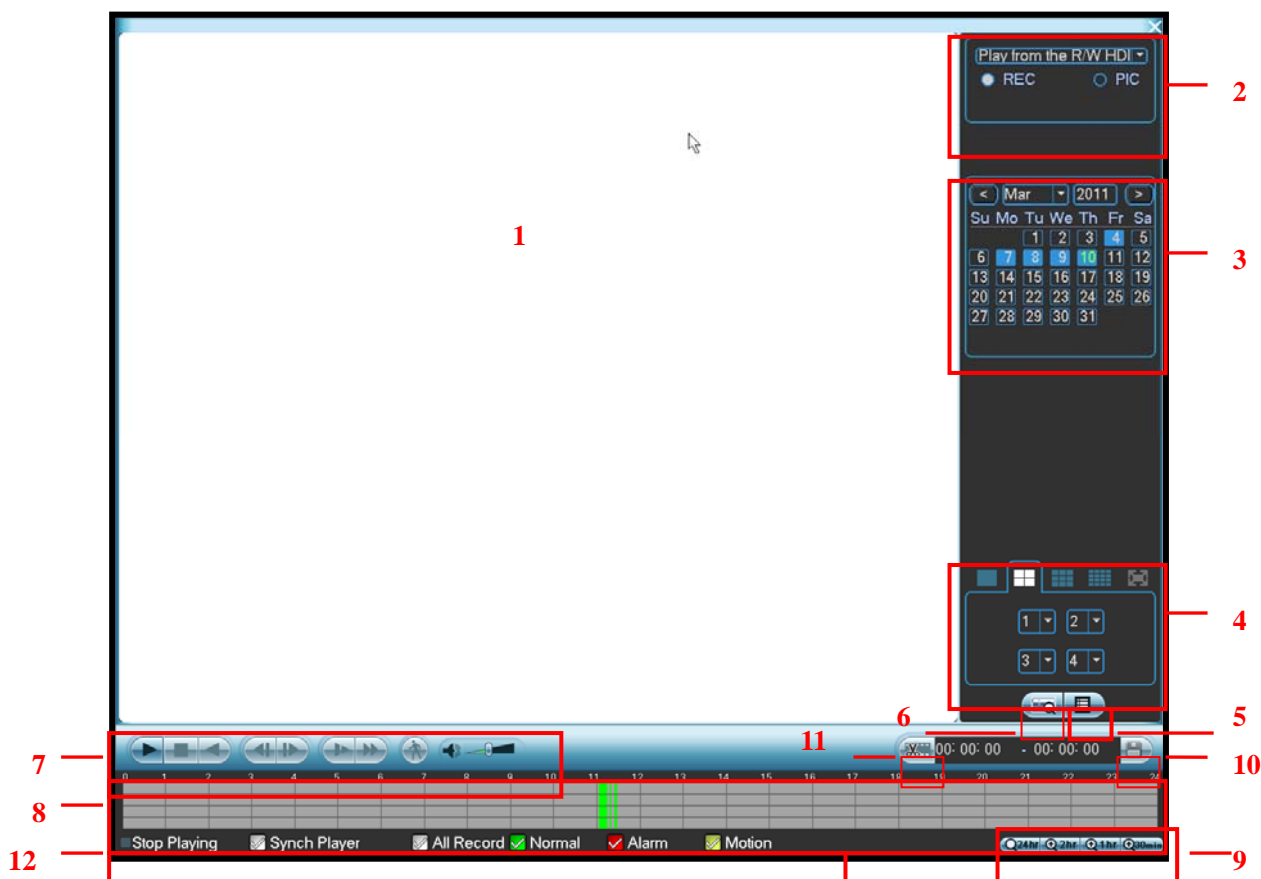



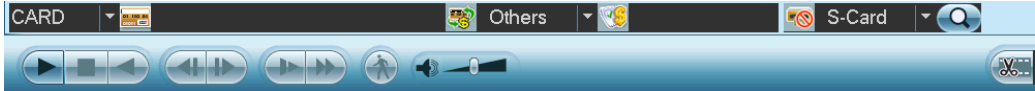















Figure 4-6

Please refer to the following sheet for more information.

SN	Name	Function
1	Display window	<ul style="list-style-type: none"> ● Here is to display the searched picture or file. ● Support 1/4/9/16-window playback.
2	Search type	<ul style="list-style-type: none"> ● Here you can select to search the picture or the recorded file. ● You can select to play from the read-write HDD, from peripheral device or from redundancy HDD. ● Before you select to play from the peripheral device, please connect the corresponding peripheral device. You can view all record files of the root directory of the peripheral device. Click the Browse button; you can select the file you want to play. <p>Important Redundancy HDD does not support picture backup function, but it supports picture playback function. You can select to play from redundancy HDD if there are pictures on the redundancy HDD.</p>
3	Calendar	<ul style="list-style-type: none"> ● The blue highlighted date means there is picture or file. Otherwise, there is no picture or file. ● In any play mode, click the date you want to see, you can see the corresponding record file trace in the time bar.
4	Playback mode and channel	<ul style="list-style-type: none"> ● Playback mode: 1/4/9/16. (It may vary due to different series.) ◇ In 1-window playback mode: you can select 1-16 channels. ◇ In 4-window playback mode: you can select 4 channels according to your requirement.

	selection pane.	<ul style="list-style-type: none"> ✧ In 9-window playback mode, you can switch between 1-8 and 9-16 channels. ✧ In 16-window playback mode, you can switch between 1-16 and 17-32 channels. ● The time bar will change once you modify the playback mode or the channel option. 	
5	File list switch button	<ul style="list-style-type: none"> ● Double click it, you can view the picture/record file list of current day. ● The file list is to display the first channel of the record file. ● The system can display max 128 files in one time. Use the ▲/▼ or the mouse to view the file. Select one item, and then double click the mouse or click the ENTER button to playback. ● You can input the period in the following interface to begin accurate search.  <ul style="list-style-type: none"> ● File type: R—regular record; A—external alarm record; M—Motion detect record. ● Lock file. Click the file you want to lock and click the button  to lock. The file you locked will not be overwritten. ● Search locked file: Click the button  to view the locked file. ● Return: Click button , system goes back to the calendar and channel setup interface. <p>Please note:</p> <ul style="list-style-type: none"> ● System max locks 16 files. The size of the locked file shall be less than the 1/4 of the HDD total space. The first 16G of each partition can not be locked. ● System can only lock one file at one time and can not lock the extra stream. For the file that is writing or overwriting, it can not be locked. 	
6	Card number search	<p>The card number search interface is shown as below.</p> 	
7	Playback control pane.		<p>Play/Pause</p> <p>There are three ways for you to begin playback.</p> <ul style="list-style-type: none"> ● The play button ● Double click the valid period of the time bar. ● Double click the item in the file list. <p>In slow play mode, click it to switch between play/pause.</p>
			<p>Stop</p>
			<p>Backward play</p> <p>In normal play mode, left click the button, the file begins backward play. Click it again to pause current play.</p> <p>In backward play mode, click  to restore normal play.</p>
			<p>In playback mode, click it to play the next or the previous section. You can click continuously when you are watching the files from the same channel.</p> <p>In normal play mode, when you pause current play, you can click  and</p>

		<p> to begin frame by frame playback. In frame by frame playback mode, click  to restore normal playback.</p>
		<p> Slow play In playback mode, click it to realize various slow play modes such as slow play 1, slow play 2, and etc.</p>
		<p> Fast forward In playback mode, click to realize various fast play modes such as fast play 1, fast play 2 and etc.</p>
		Note: The actual play speed has relationship with the software version.
		<p> Smart search</p>
		<p> The volume of the playback</p>
		<p> Click the snapshot button in the full-screen mode, the system can snapshot 1 picture per second. System supports custom snap picture saved path. Please connect the peripheral device first, click snap button on the full-screen mode, you can select or create path. Click Start button, the snapshot picture can be saved to the specified path.</p>
8	Time bar	<ul style="list-style-type: none"> ● It is to display the record type and its period in current search criteria. ● In 4-window playback mode, there are corresponding four time bars. In other playback mode, there is only one time bar. ● Use the mouse to click one point of the color zone in the time bar, system begins playback. ● The time bar is beginning with 0 o'clock when you are setting the configuration. The time bar zooms in the period of the current playback time when you are playing the file. ● The green color stands for the regular record file. The red color stands for the external alarm record file. The yellow stands for the motion detect record file.
9	Time bar unit	<ul style="list-style-type: none"> ● The option includes: 24H, 12H, 1H and 30M. The smaller the unit, the larger the zoom rate. You can accurately set the time in the time bar to playback the record. ● The time bar is beginning with 0 o'clock when you are setting the configuration. The time bar zooms in the period of the current playback time when you are playing the file.
10	Backup	<p>Select the file(s) you want to backup from the file list. System max supports files from four channels. Then click the backup button, now you can see the backup menu. Click the start button to begin the backup operation. Check the file again you can cancel current selection. System max supports to display 32 files from one channel.</p>
11	Clip	<ul style="list-style-type: none"> ● It is to edit the file. ● Please play the file you want to edit and then click this button when you want to edit. You can see the corresponding slide bar in the time bar of the corresponding channel. You can adjust the slide bar or input the accurate time to set the file end time. Click this button again and then save current contents in a new file. .
12	Record	In any play mode, the time bar will change once you modify the search type.

	type	
13	Smart search	<ul style="list-style-type: none"> ● When system is playing, you can select a zone in the window to begin motion detect. Click the motion detect button to begin play. ● Current button is null once the motion detect play has begun. ● The system will take the whole play zone as the motion detect region by default. ● The motion detect play stopped once you switch the play file. ● Operations such as set time bar, click the play button, or any file list operation will stop current motion detect play.
Other Functions		
14	Other channel synchronization switch to play when playback	When playing the file, click the number button, system can switch to the same period of the corresponding channel to play.
15	Digital zoom	When the system is in full-screen playback mode, left click the mouse in the screen. Drag your mouse in the screen to select a section and then left click mouse to realize digital zoom. You can right click mouse to exit.
16	Manually switch channel when playback	During the file playback process, you can switch to other channel via the dropdown list or rolling the mouse. This function is null if there is no record file or system is in smart search process.

Note:

All the operations here (such as playback speed, channel, time and progress) have relationship with hardware version. Some series NVRs do not support some functions or playback speeds.

4.5 Information

Here is for you to view system information. There are total seven items: HDD (hard disk information), BPS (data stream statistics), log, Version, online user, remote device information and network info. See Figure 4-7.

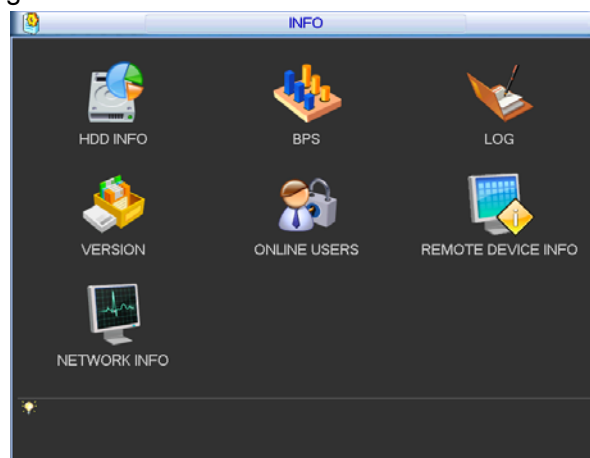

Figure 4-7

4.5.1 HDD Information

Here is to list hard disk type, total space, free space, and status. See Figure 4-8.

○ means current HDD is normal.. - means there is no HDD.

If disk is damaged, system shows as “?”. Please remove the broken hard disk before you add a new one.

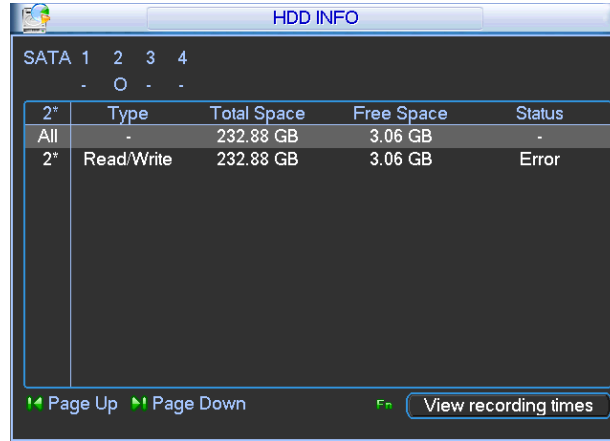

Figure 4-8

In Figure 4-8, click view record d time button, HDD record time information interface is shown as in Figure 4-9.



Figure 4-9

Parameter	Function
SATA	1-4 here means there are 4 HDDS. When HDD is working properly, system is shown as O. . “_” means there is no HDD.
SN	You can view the HDD amount the device connected to; * means the second HDD is current working HDD.
Type	The corresponding HDD property.
Total space	The HDD total capacity.

Free space	The HDD free capacity.
Status	HDD can work properly or not.
Bad track	Display there is bad track or not.
Page up	Click it to view previous page.
Page down	Click it to view the next page.
View recording time	Click it to view HDD record information (file start time and end time).
View HDD type and capability	Click it to view HDD property, status and etc,

4.5.2 BPS

Here is for you to view current video data stream (KB/s) and occupied hard disk storage (MB/h). See Figure 4-10.

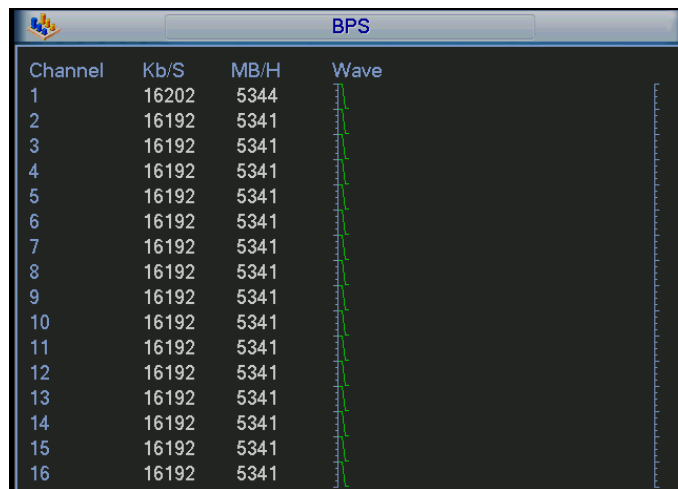

Figure 4-10

For the 32-channel series product, the interface is shown as below. See Figure 4-11.

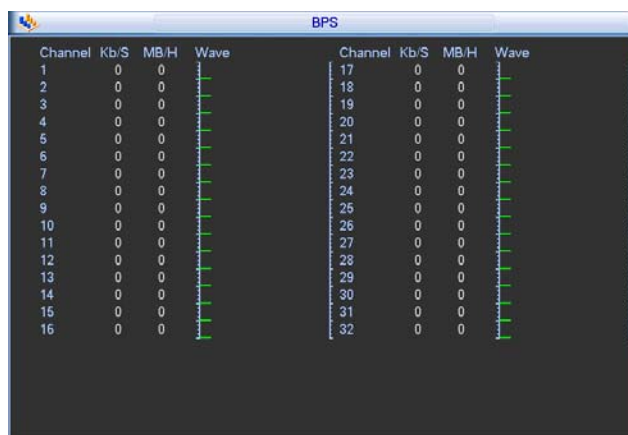

Figure 4-11

4.5.3 Log

Here is for you to view system log file. System lists the following information. See Figure 4-12. Log types include system operation, configuration operation, data management, alarm event, record operation, log clear and etc.

- Start time/end time: Pleased select start time and end time, then click search button. You can view the log files in a list. System max displays 100 logs in one page. It can max save 1024 log files. Please use page up/down button on the interface or the front panel to view more.
- Backup: Please select a folder you want to save; you can click the backup button to save the log files. After the backup, you can see there is a folder named Log_time on the backup path. Double click the folder, you can see the log file
- Details: Click the Details button or double click the log item, you can view the detailed information. See Figure 4-13. Here you can use rolling bar to view information, or you can use Page up/Page down to view other log information. For the alarm event log such as video loss, you can click the Playback button at the bottom right corner to playback.

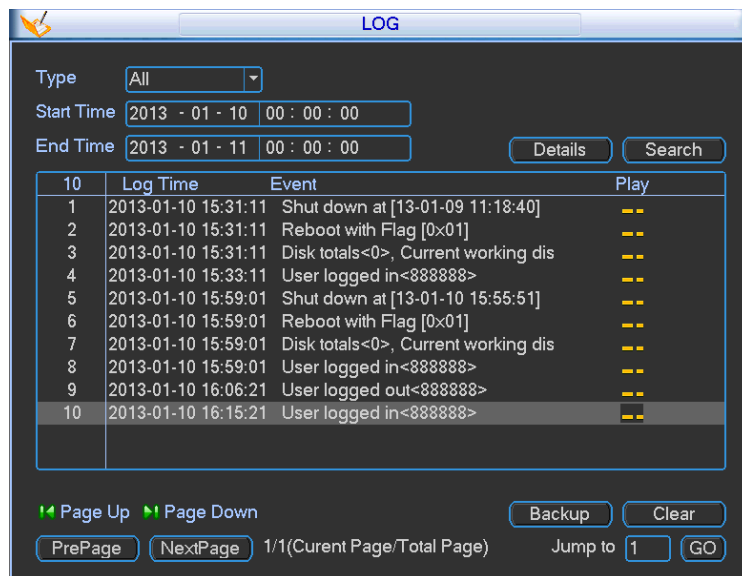

Figure 4-12

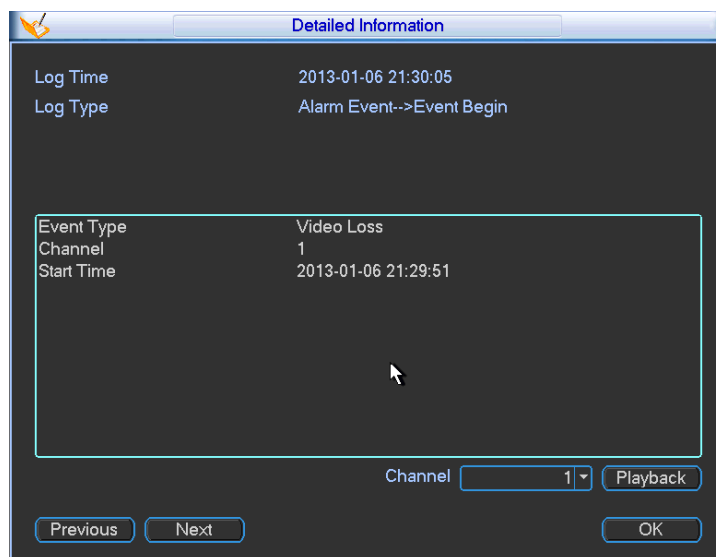

Figure 4-13

4.5.4 Version

Here is for you to view some version information. See Figure 4-14.

- Channel
- Alarm in
- Alarm out
- System version:
- Build Date
- Web
- Serial number

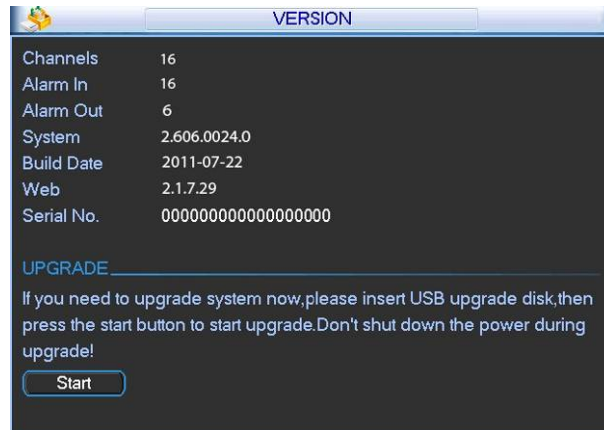

Figure 4-14

4.5.5 Online Users

Here is for you manage online users connected to the local device. See Figure 4-15.

You can disconnect one user or block one user if you have proper system right.

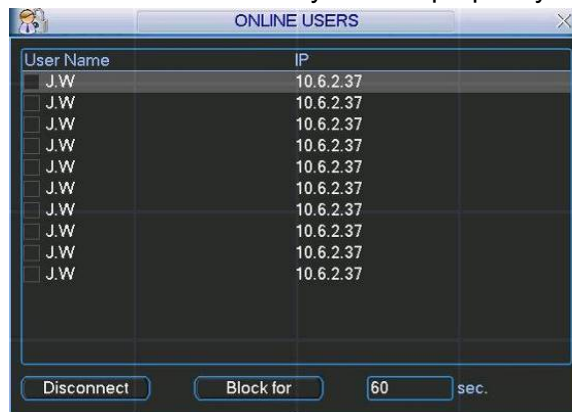

Figure 4-15

4.5.6 Remote Device Information

Here you can view the channel status of the remote device, connection log and etc.

Channel status: Here you can view the IPC status of the corresponding channel such as motion detect, video loss, camera masking, alarm and etc. See Figure 4-16.

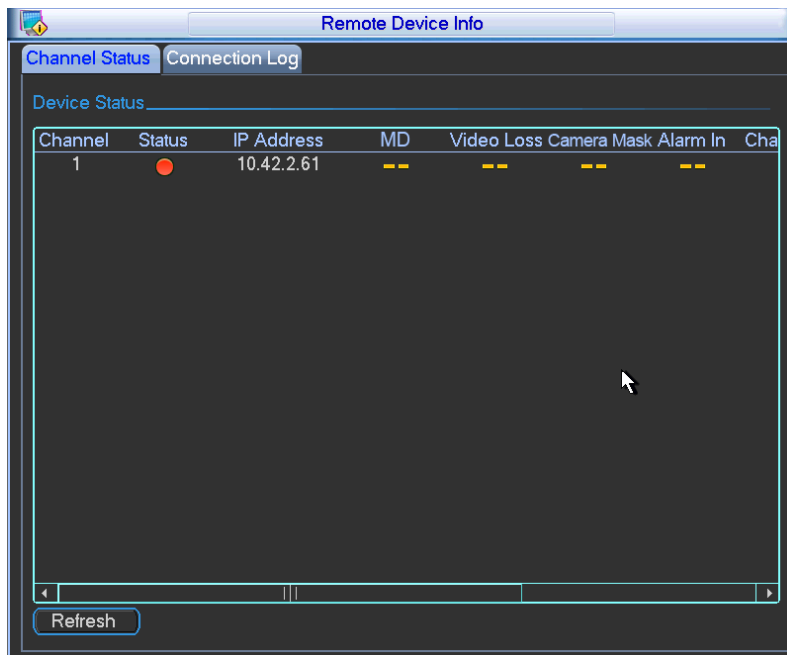

Figure 4-16

Connection log: In this interface, you can search the IPC log information of the corresponding channel. It includes IPC online, offline and etc. See Figure 4-17.

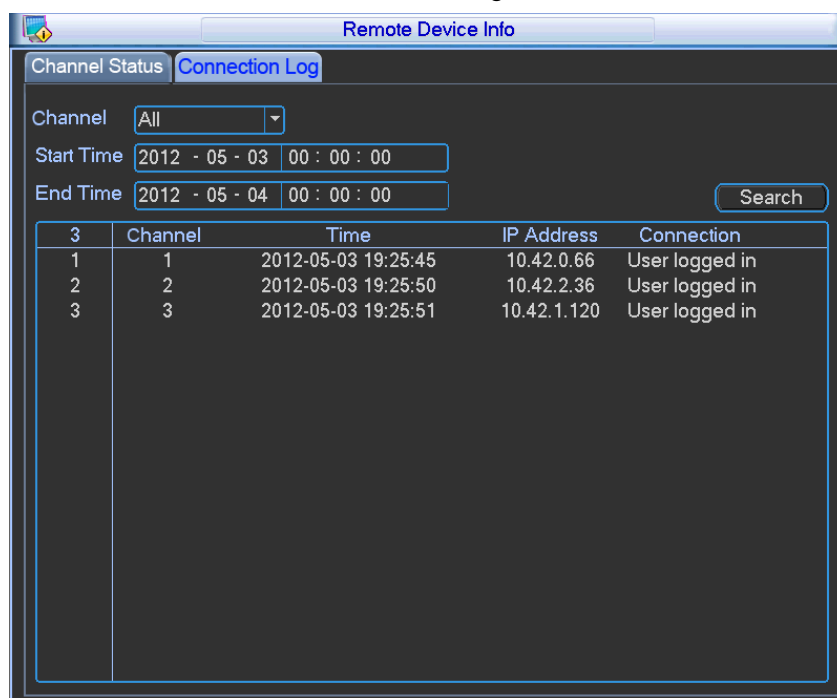

Figure 4-17

4.5.7 Network Info

In this interface, you can see network test and network load information.

4.5.7.1 Network Test

Network test interface is shown as in Figure 4-18.

Destination IP: Please input valid IPV4 address and domain name.

Test: Click it to test the connection with the destination IP address. The test results can display average delay and packet loss rate and you can also view the network status as OK, bad, no

connection and etc.

Network Sniffer backup: Please insert USB2.0 device and click the Refresh button, you can view the device on the following column. You can use the dropdown list to select peripheral device. Click Browse button to select the snap path. The steps here are same as preview backup operation.

You can view all connected network adapter names (including Ethernet, PPPoE, WIFI, and 3G), you can click the button  on the right panel to begin Sniffer. Click the grey stop button to stop. Please note system can not Sniffer several network adapters at the same time.

After Sniffer began, you can exit to implement corresponding network operation such as login WEB, monitor. Please go back to Sniffer interface to click  stop Sniffer. System can save the packets to the specified path. The file is named after "Network adapter name+time". You can use software such as Wireshark to open the packets on the PC for the professional engineer to solve complicated problems.

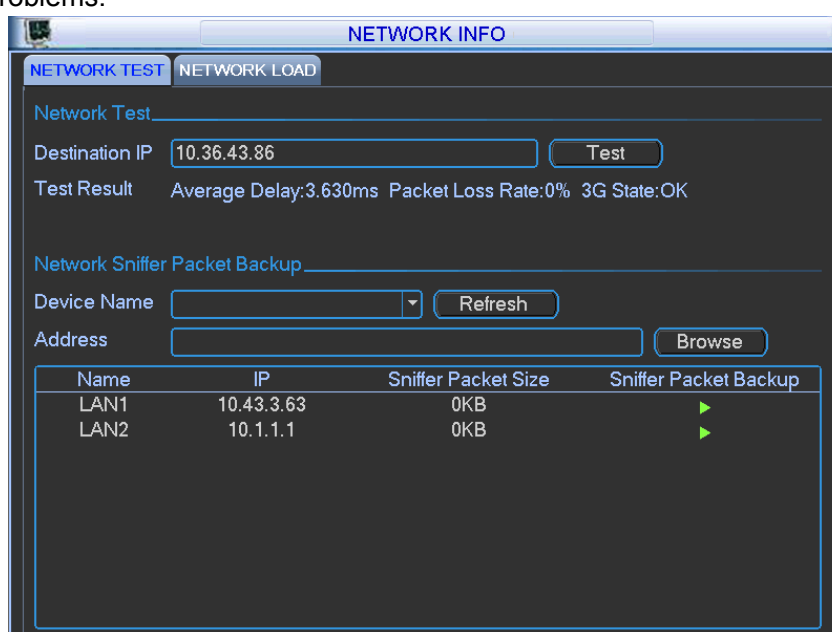

Figure 4-18

4.5.7.2 Network Load

Network load is shown as in Figure 4-19. Here you can view the follow statistics of the device network adapter.

Here you can view information of all connected network adapters. The connection status is shown as offline if connection is disconnected. Click one network adapter, you can view the flow statistics such as send rate and receive rate at the top panel

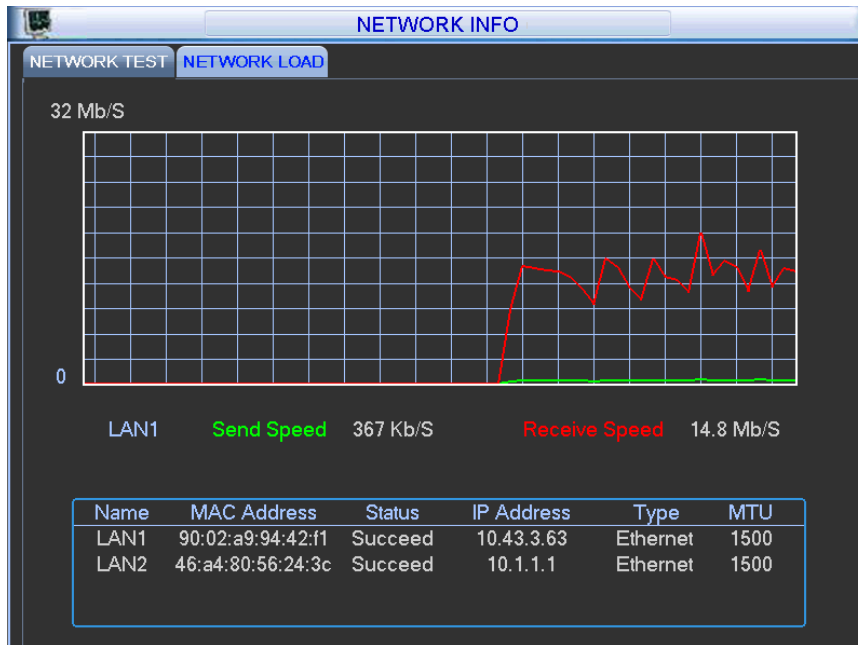

Figure 4-19

4.6 Setting

In main menu, highlight setting icon and double click mouse. System setting interface is shown as below. See Figure 4-20.

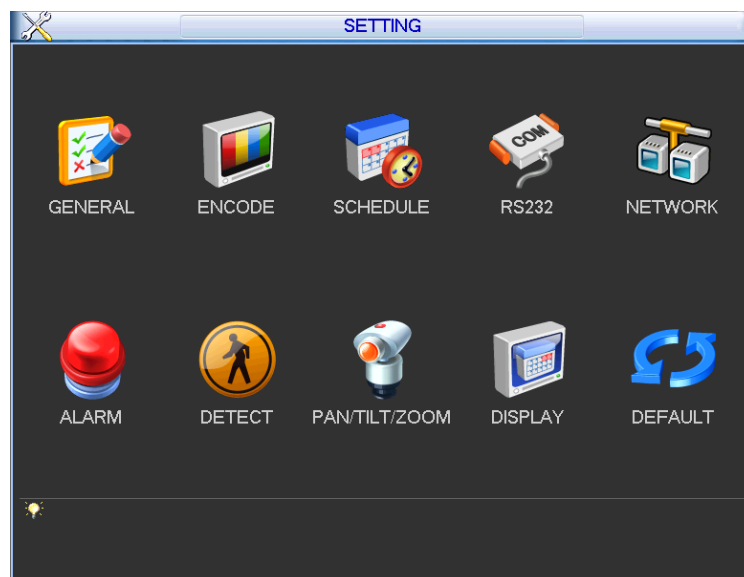

Figure 4-20

Important

Please note you need to have the proper right to implement the following operation.

4.6.1 General

General setting includes the following items. See Figure 4-21.

- System time: Here is for you to set system time
- Date format: There are three types: YYYY-MM-DD: MM-DD-YYYYY or DD-MM-YYYY.
- Date separator: There are three denotations to separate date: dot, beeline and solidus.

- DST: Here you can set DST time and date. Please enable DST function and then click set button. You can see an interface is shown as in Figure 4-22. Here you can set start time and end time by setting corresponding week setup. In Figure 4-22, enable date button, you can see an interface is shown as in Figure 4-23. Here you can set start time and end time by setting corresponding date setup.
- Time format: There are two types: 24-hour mode or 12-hour mode.
- Language: System supports various languages: Chinese (simplified), Chinese (Traditional), English, Italian, Japanese, French, Spanish (All languages listed here are optional. Slight difference maybe found in various series.)
- HDD full: Here is for you to select working mode when hard disk is full. There are two options: stop recording or rewrite. If current working HDD is overwritten or the current HDD is full while the next HDD is no empty, then system stops recording, If the current HDD is full and then next HDD is not empty, then system overwrites the previous files.
- Pack duration: Here is for you to specify record duration. The value ranges from 60 to 120 minutes. Default value is 60 minutes.
- Device No: When you are using one remote control (not included in the accessory bag) to control several NVRs, you can give a name to each NVR for your management.
- Video standard: There are two formats: NTSC and PAL.
- Realtime play: It is to set playback time you can view in the preview interface. The value ranges from 5 to 60 minutes.
- Device ID: Please input a corresponding device name here.
- Holiday setting: Click it you can see an interface shown as in Figure 4-24. Here you can set holiday date. Please go to the Holidays Period interface to set the holiday date record setup.
 - ✧ When you enable Holiday settings and schedule setup at the same time, holiday setting has the priority. If the selected day is a holiday, then system records as you set in holiday setting. If it is not a holiday, system records as you set in Schedule interface. Please note you need to go to chapter 4.6.3 Schedule to enable Holiday setup. Otherwise you can not enable holiday record setup.
 - ✧ Please note, there is no year setup on the holiday setting. For example, if you set 30th Oct, 2012 as a holiday, then the date of 30th Oct in each year will be set as a holiday. So, general speaking, your holiday setup in other year may also affect the holiday setup in 2012.
- Mouse property: Click mouse setup button, you can go to mouse setup interface. See Figure 4-25. You can set double click speed via dragging the slide bard. You can Click Default button to restore default setup.
- Startup wizard: Once you check the box here, system will go to the startup wizard directly when the system restarts the next time. Otherwise, it will go to the login interface.
- Auto logout: Here is for you to set auto logout interval once login user remains inactive for a specified time. Value ranges from 0 to 60 minutes.
- Navigation bar: Check the box here, system displays the navigation bar on the interface.
- IPC Time Sync: You can input an interval here to synchronize the NVR time and IPC time.
- Snap times: Here you can set snap picture amount of one click.

Note:

Since system time is very important, do not modify time casually unless there is a must!

Before your time modification, please stop record operation first!

After completing all the setups please click save button, system goes back to the previous menu.

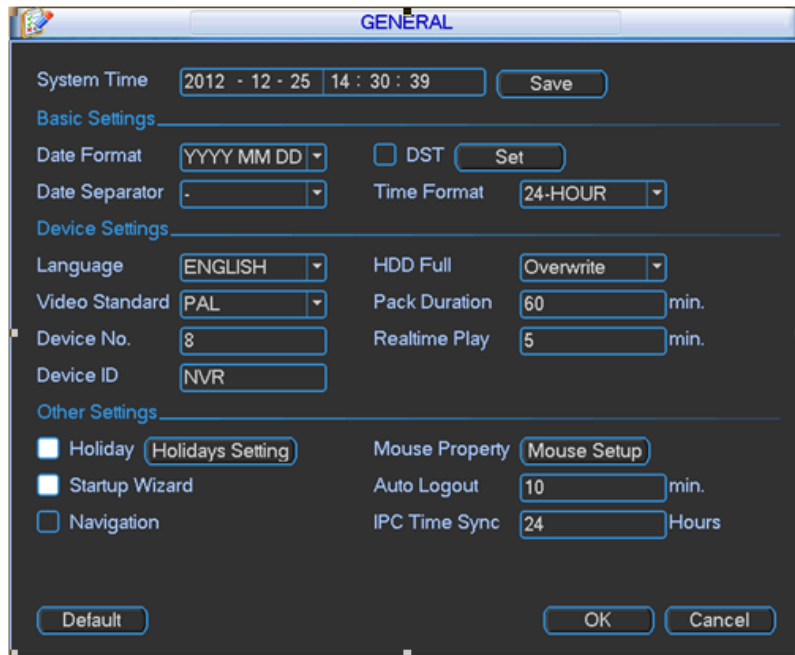

Figure 4-21

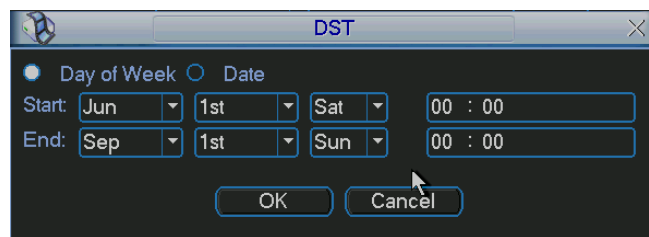

Figure 4-22

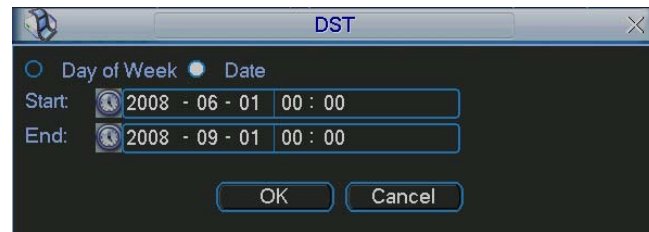

Figure 4-23

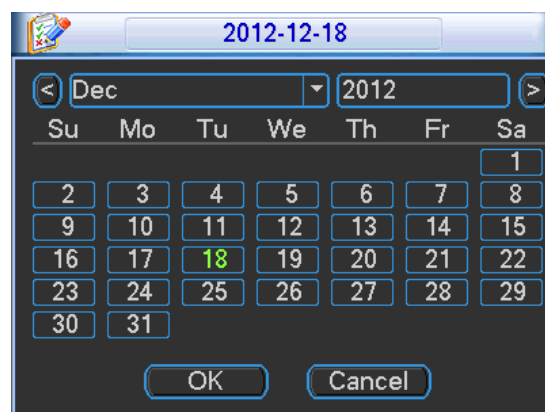

Figure 4-24

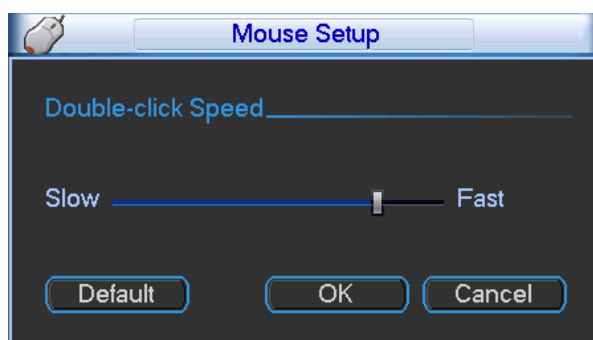

Figure 4-25

4.6.2 Encode

Encode setting includes the following items. See Figure 4-26.

Please note some series do not support extra stream.

- Channel: Select the channel you want.
- Type: Please select from the dropdown list. There are three options: regular/motion detect/alarm. You can set the various encode parameters for different record types.
- Compression: System supports H.264, MPEG4, MJPEG and etc.
- Resolution: The mainstream resolution type is IPC's encoding config. Generally there is D1/720P/1080P.
- Frame rate: It ranges from 1f/s to 25f/s in NTSC mode and 1f/s to 30f/s in PAL mode.
- Bit rate type: System supports two types: CBR and VBR. In VBR mode, you can set video quality.
- Quality: There are six levels ranging from 1 to 6. The sixth level has the highest image quality.
- Video/audio: You can enable or disable the video/audio.
- Overlay: Click overlay button, you can see an interface is shown in Figure 4-27.
 - ✧ Cover area (Privacy mask): Here is for you to set privacy mask section. You can drag you mouse to set proper section size. In one channel video, system max supports 4 zones in one channel.
 - ✧ Preview/monitor: privacy mask has two types. Preview and Monitor. Preview means the privacy mask zone can not be viewed by user when system is in preview status. Monitor means the privacy mask zone can not be view by the user when system is in monitor status.
 - ✧ Time display: You can select system displays time or not when you playback. Please click set button and then drag the title to the corresponding position in the screen.
 - ✧ Channel display: You can select system displays channel number or not when you playback. Please click set button and then drag the title to the corresponding position in the screen.
 - ✧ Copy: After you complete the setup, you can click Copy button to copy current setup to other channel(s). You can see an interface is shown as in Figure 4-28. You can see current channel number is grey. Please check the number to select the channel or you can check the box ALL. Please click the OK button in Figure 4-28 and Figure 4-26 respectively to complete the setup. Please note, once you check the All box, you set same encode setup for all channels. Audio/video enable box, overlay button and the copy button is shield. See Figure 4-29.

Please highlight icon  to select the corresponding function.

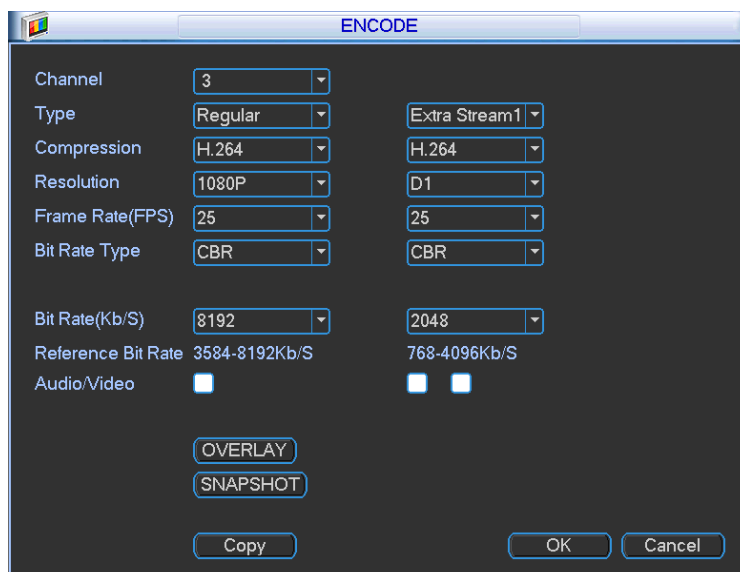

Figure 4-26

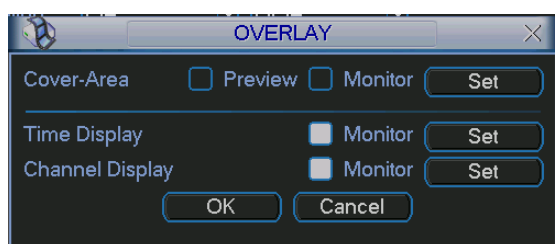

Figure 4-27

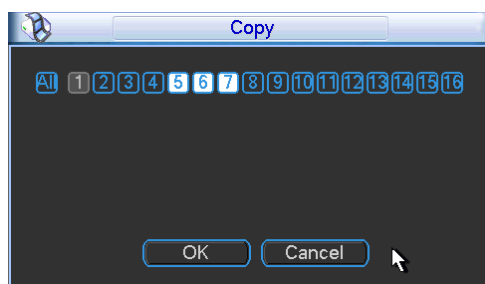

Figure 4-28

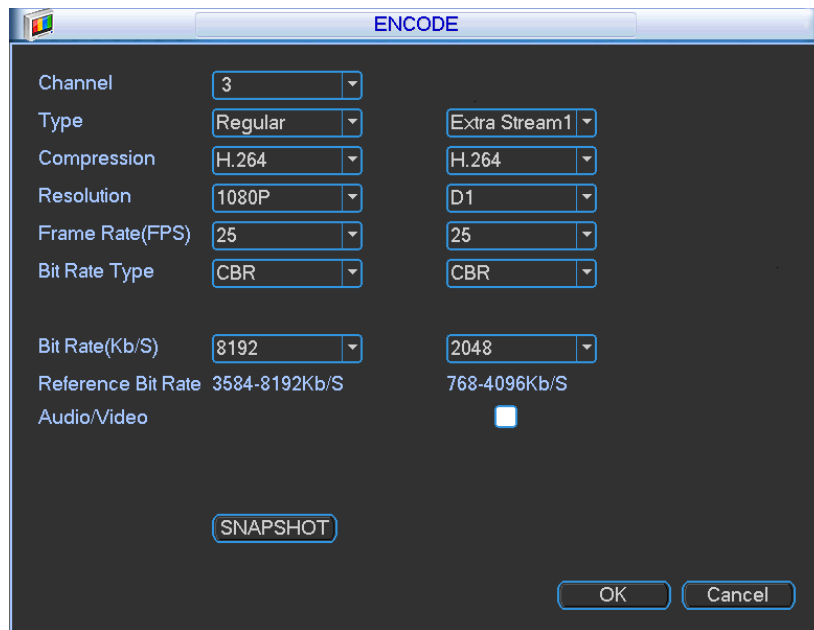

Figure 4-29

4.6.3 Schedule

In the main menu, from setting to schedule, you can go to schedule menu. See Figure 4-30.

- Channel: Please select the channel number first. You can select “all” if you want to set for the whole channels.
- Week day: There are eight options: ranges from Saturday to Sunday and all.
- Pre-record: System can pre-record the video before the event occurs into the file. The value ranges from 1 to 30 seconds depending on the bit stream.
- Redundancy: System supports redundancy backup function. It allows you backup recorded file in two disks. You can highlight Redundancy button to activate this function. Please note, before enable this function, please set at least one HDD as redundant. (Main menu->Advanced->HDD Management). **Please note this function is null if there is only one HDD.**
- Snapshot: You can enable this function to snapshot image when an alarm occurs.
- Record types: There are four types: regular, motion detection (MD), Alarm, MD & alarm.
- Holiday: Highlight the button here, the holiday settings in General interface (Chapter 4.6.1) becomes activated.

Please highlight icon to select the corresponding function. After completing all the setups please click save button, system goes back to the previous menu.

At the bottom of the menu, there are color bars for your reference. Green color stands for regular recording, yellow color stands for motion detection and red color stands for alarm recording. The white means the MD and alarm record is valid. Once you have set to record when the MD and alarm occurs, system will not record neither motion detect occurs nor the alarm occurs.

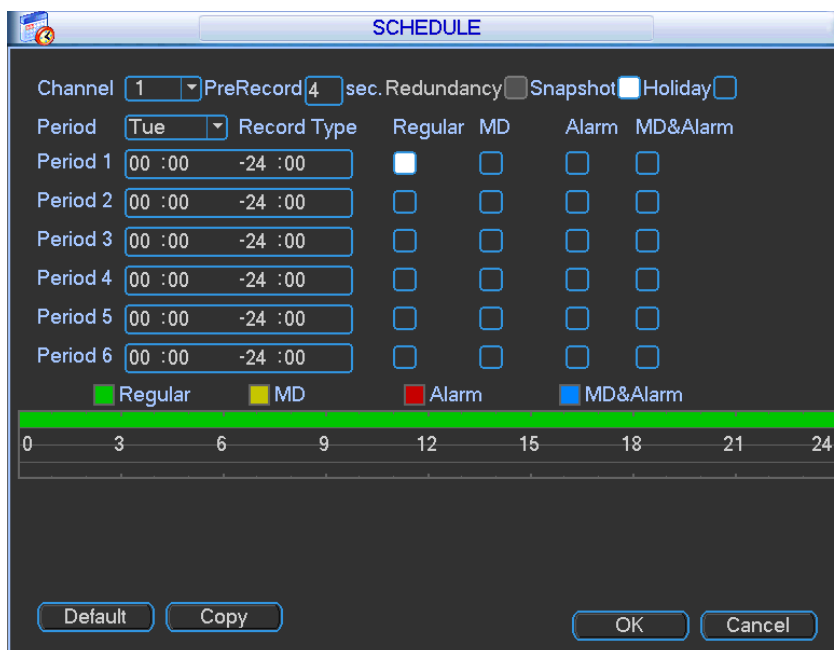

Figure 4-30

4.6.3.1 Quick Setup

Copy function allows you to copy one channel setup to another. After setting in channel 1, click Copy button, you can go to interface Figure 4-31. You can see current channel name is grey such as channel 1. Now you can select the channel you want to paste such as channel 5/6/7. If you want to save current setup of channel 1 to all channels, you can click the first box "ALL". Click the OK button to save current copy setup. Click the OK button in the Encode interface, the copy function succeeded.

Please note, if you select ALL in Figure 4-31, the record setup of all channels are the same and the Copy button becomes hidden.

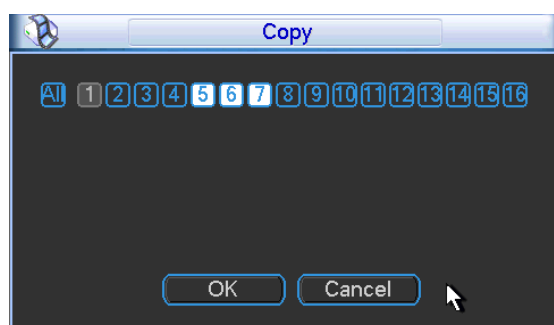

Figure 4-31

4.6.4 RS232

RS232 interface is shown as below. There are five items. See Figure 4-32.

- Function: There are various devices for you to select. Console is for you to use the COM or mini-end software to upgrade or debug the program. The control keyboard is for you to control the device via the special keyboard. Transparent COM (adapter) is to connect to the PC to transfer data directly. Protocol COM is for card overlay function. Network keyboard is for you to use the special keyboard to control the device. PTZ matrix is to connect to the peripheral matrix control.
- Baud rate: You can select proper baud rate.

- Data bit: You can select proper data bit. The value ranges from 5 to 8.
- Stop bit: There are three values: 1/1.5/2.
- Parity: there are five choices: none/odd/even/space mark.

System default setup is:

- Function: Console
- Baud rate:115200
- Data bit:8
- Stop bit:1
- Parity: None

After completing all the setups please click save button, system goes back to the previous menu.

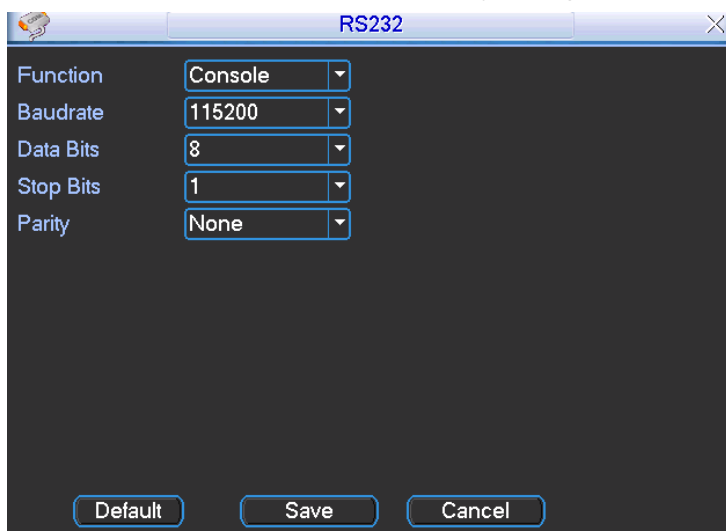

Figure 4-32

4.6.5 Network

Here is for you to input network information. See Figure 4-33.

- IP Version: There are two options: IPv4 and IPv6. Right now, system supports these two IP address format and you can access via them.
- MAC address: The host in the LAN can get a unique MAC address. It is for you to access in the LAN. It is read-only.
- IP address: Here you can use up/down button (▲▼) or input the corresponding number to input IP address. Then you can set the corresponding subnet mask the default gateway.
- Subnet prefix: The input value ranges from 0 to 128. It is to mark a specified network MAC address. Usually it includes an organization of multiple-level.
- Default gateway: Here you can input the default gateway. **Please note system needs to check the validity of all IPv6 addresses. The IP address and the default gateway shall be in the same IP section. That is to say, the specified length of the subnet prefix shall have the same string.**
- DHCP: It is to auto search IP. When enable DHCP function, you can not modify IP/Subnet mask /Gateway. These values are from DHCP function. If you have not enabled DHCP function, IP/Subnet mask/Gateway display as zero. You need to disable DHCP function to view current IP information. Besides, when PPPoE is operating, you can not modify IP/Subnet mask /Gateway.
- TCP port: Default value is 37777. You can change if necessary.
- UDP port: Default value is 37778. You can change if necessary.

- HTTP port: Default value is 80.
- RTSP port: Default value is 554.

Important: System needs to reboot after you changed and saved any setup of the above four ports. Please make sure the port values here do not conflict.

- Max connection: system support maximal 20 users. 0 means there is no connection limit.
- MTU: It is to set MTU value of the network adapter. The value ranges from 1280-7200 bytes. The default setup is 1500 bytes. Please note MTU modification may result in network adapter reboot and network becomes off. That is to say, MTU modification can affect current network service. System may pop up dialog box for you to confirm setup when you want to change MTU setup. Click OK button to confirm current reboot, or you can click Cancel button to terminate current modification. Before the modification, you can check the MTU of the gateway; the MTU of the NVR shall be the same as or is lower than the MTU of the gateway. In this way, you can reduce packets and enhance network transmission efficiency.

The following MTU value is for reference only.

- ✧ 1500: Ethernet information packet max value and it is also the default value. It is the typical setup when there is no PPPoE or VPN. It is the default setup of some router, switch or the network adapter.
- ✧ 1492: Recommend value for PPPoE.
- ✧ 1468: Recommend value for DHCP.
- ✧ Please make sure MTU port does not conflict with other ports.

- Preferred DNS server: DNS server IP address.
- Alternate DNS server: DNS server alternate address.
- Transfer mode: Here you can select the priority between fluency/video qualities.
- LAN download: System can process the downloaded data first if you enable this function. The download speed is 1.5X or 2.0X of the normal speed.

Important

For the IP address of IPv6 version, default gateway, preferred DNS and alternate DNS, the input value shall be 128-digit. It shall not be left in blank.

After completing all the setups please click save button, system goes back to the previous menu.

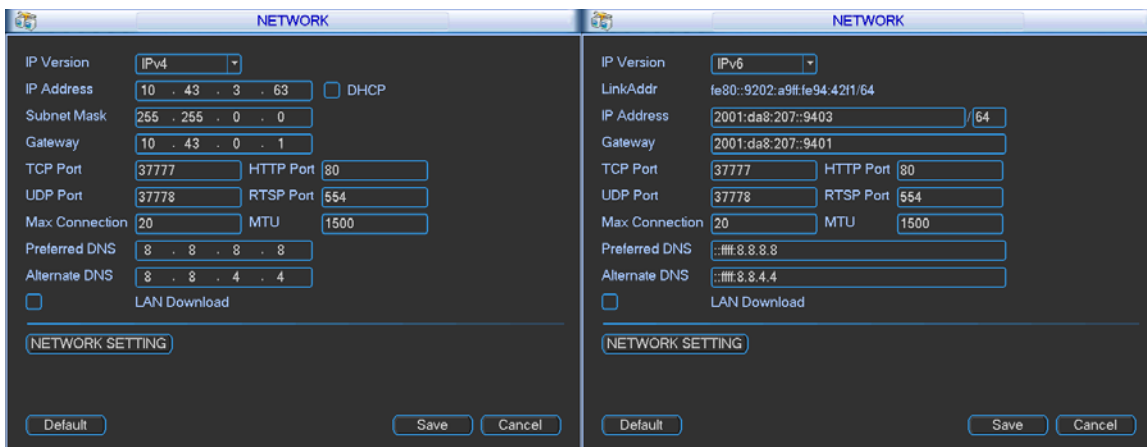

Figure 4-33

4.6.5.1 Network Setting

Network setting interface is shown as in Figure 4-34. Please draw a circle to enable corresponding function and then double click current item to go to setup interface.

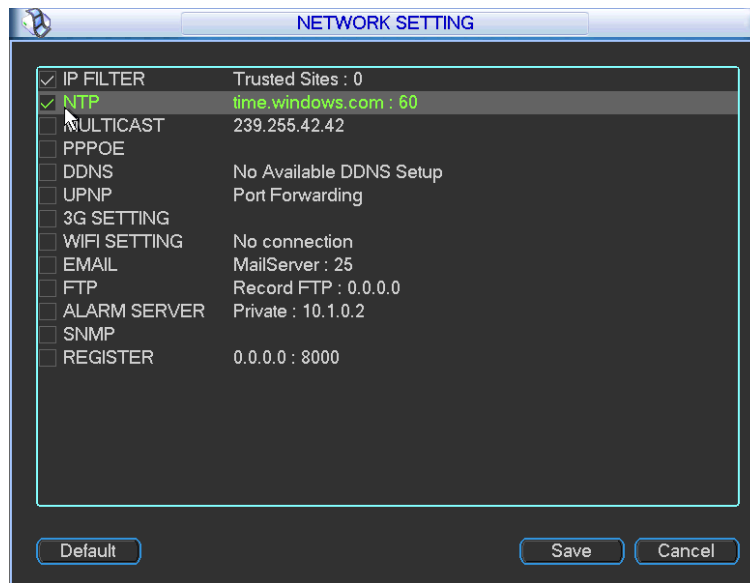

Figure 4-34

4.6.5.2 IP Filter

IP filter interface is shown as in Figure 4-35. You can add IP in the following list. The list supports max 64 IP addresses. System supports valid address of IPv4 and IPv6. **Please note system needs to check the validity of all IPv6 addresses.**

After you enabled trusted sites function, only the IP listed below can access current NVR.

If you enable blocked sites function, the following listed IP addresses can not access current NVR.

- Enable: Highlight the box here, you can check the trusted site function and blocked sites function. You can not see these two modes if the Enable button is grey.
- Type: You can select trusted site and blacklist from the dropdown list. You can view the IP address on the following column.
- Start address/end address: Select one type from the dropdown list, you can input IP address in the start address and end address. Now you can click Add IP address or Add IP section to add.
 - a) For the newly added IP address, it is in enable status by default. Remove the ✓ before the item, then current item is not in the list.
 - b) System max supports 64 items.
 - c) Address column supports IPv4 or IPv6 format. If it is IPv6 address, system can optimize it. For example, system can optimize aa:0000: 00: 00aa: 00aa: 00aa: 00aa: 00aa as aa:: aa: aa: aa: aa: aa: aa.
 - d) System automatically removes space if there is any space before or after the newly added IP address.
 - e) System only checks start address if you add IP address. System check start address and end address if you add IP section and the end address shall be larger than the start address.
 - f) System may check newly added IP address exists or not. System does not add if input IP address does not exist.
- Delete: Click it to remove specified item.
- Edit: Click it to edit start address and end address. System can check the IP address validity after the edit operation and implement IPv6 optimization.

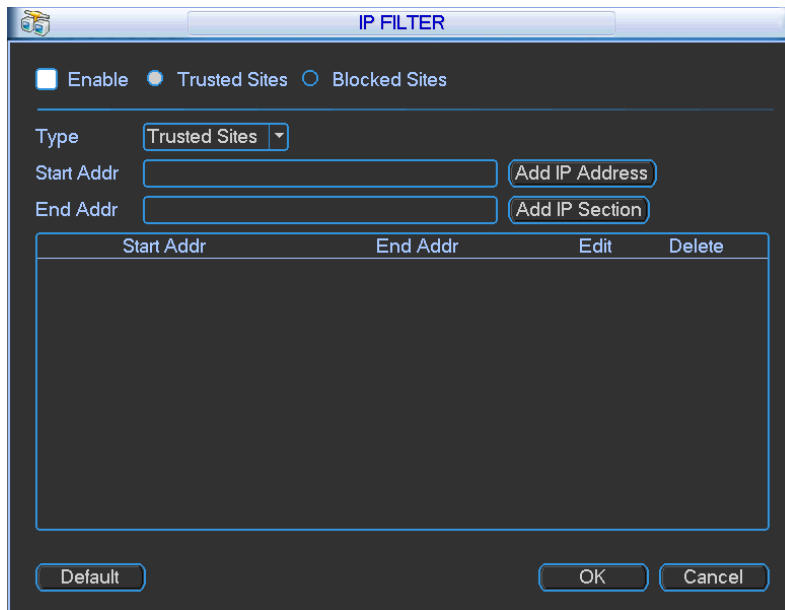

Figure 4-35

4.6.5.3 NTP Setup

You need to install SNTP server (Such as Absolute Time Server) in your PC first. In Windows XP OS, you can use command “net start w32time” to boot up NTP service.

NTP setup interface is shown as in Figure 4-36.

- Host IP: Input your PC address.
- Port: This series NVR supports TCP transmission only. Port default value is 123.
- Update interval: minimum value is 1. Max value is 65535. (Unit: minute)
- Time zone: select your corresponding time zone here.
- Update period: You can input interval here.
- Manual update: It allows you to synchronize the time with the server manually.

Here is a sheet for your time zone setup.

City /Region Name	Time Zone
London	GMT+0
Berlin	GMT+1
Cairo	GMT+2
Moscow	GMT+3
New Deli	GMT+5
Bangkok	GMT+7
Beijing (Hong Kong)	GMT+8
Tokyo	GMT+9
Sydney	GMT+10
Hawaii	GMT-10
Alaska	GMT-9
Pacific Time(P.T)	GMT-8
American Mountain Time(M.T)	GMT-7
American Central Time(C.T)	GMT-6
American Eastern Time(E.T)	GMT-5
Atlantic Time	GMT-4

Brazil	GMT-3
Middle Atlantic Time	GMT-2

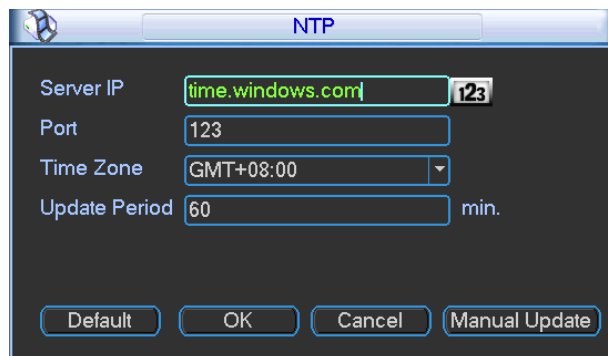

Figure 4-36

4.6.5.4 Multicast

Multiple-cast setup interface is shown as in Figure 4-37.

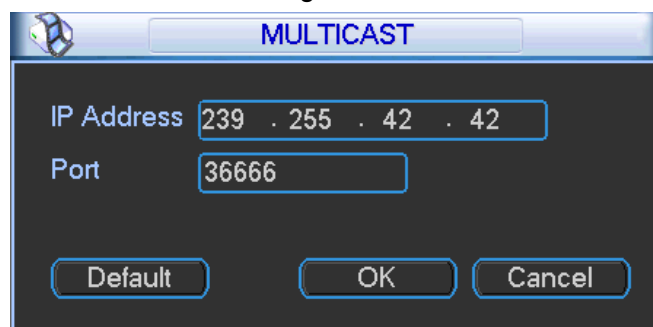

Figure 4-37

Here you can set a multiple cast group. Please refer to the following sheet for detailed information.

- IP multiple cast group address
 - 224.0.0.0-239.255.255.255
 - “D” address space
 - The higher four-bit of the first byte=“1110”
- Reserved local multiple cast group address
 - 224.0.0.0-224.0.0.255
 - TTL=1 When sending out telegraph
 - For example
 - 224.0.0.1 All systems in the sub-net
 - 224.0.0.2 All routers in the sub-net
 - 224.0.0.4 DVMRP router
 - 224.0.0.5 OSPF router
 - 224.0.0.13 PIMv2 router
- Administrative scoped addressees
 - 239.0.0.0-239.255.255.255
 - Private address space
 - Like the single broadcast address of RFC1918
 - Can not be used in Internet transmission
 - Used for multiple cast broadcast in limited space.

Except the above mentioned addresses of special meaning, you can use other addresses. For example:

Multiple cast IP: 235.8.8.36

Multiple cast PORT: 3666.

After you logged in the Web, the Web can automatically get multiple cast address and add it to the multiple cast groups. You can enable real-time monitor function to view the view.

Please note multiple cast function applies to special series only.

4.6.5.5 PPPoE

PPPoE interface is shown as in Figure 4-38.

Input “PPPoE name” and “PPPoE password” you get from your ISP (Internet service provider).

Click save button, you need to restart to activate your configuration.

After rebooting, NVR will connect to internet automatically. The IP in the PPPoE is the NVR dynamic value. You can access this IP to visit the unit.

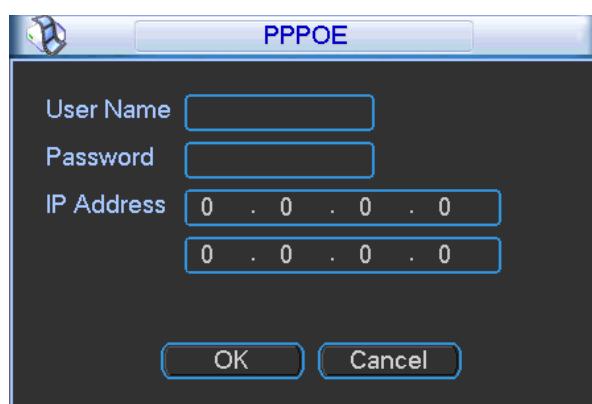

Figure 4-38

4.6.5.6 DDNS

DDNS setup interface is shown as in Figure 4-39.

You need a PC of fixed IP in the internet and there is the DDNS software running in this PC. In other words, this PC is a DNS (domain name server).

In network DDNS, please select DDNS type and highlight enable item. Then please input your PPPoE name you get from you IPS and server IP (PC with DDNS) . Click save button and then reboot system.

Click save button, system prompts for rebooting to get all setup activated.

After rebooting, open IE and input the domain name.

Now you can open DDNSServer web search page.

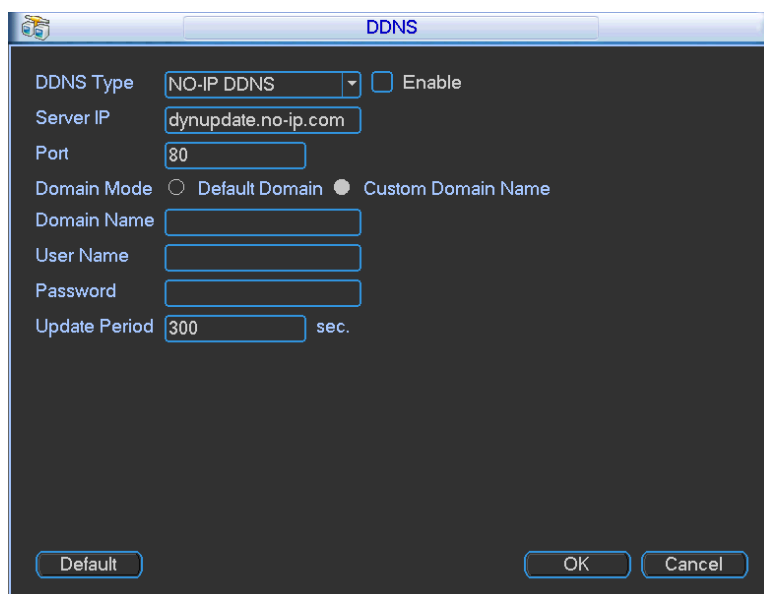

Figure 4-39

Please note NNDS type includes: CN99 DDNS, NO-IP DDNS, Quick DDNS, and DynDNS DDNS. All the DDNS can be valid at the same time, you can select as you requirement. Quick DDNS function shall work with special DDNS server and special Professional Surveillance Software (PSS).

Quick DDNS and Client-end Introduction

1) Background Introduction

Device IP is not fixed if you use ADSL to login the network. The DDNS function allows you to access the NVR via the registered domain name. Besides the general DDNS, the quick DDNS works with the device from the manufacturer so that it can add the extension function.

2) Function Introduction

The quick DDNS client has the same function as other DDNS client end. It realizes the bonding of the domain name and the IP address. Right now, current DDNS server is for our own devices only. You need to refresh the bonding relationship of the domain and the IP regularly. There is no user name, password or the ID registration on the server. At the same time, each device has a default domain name (Generated by MAC address) for your option. You can also use customized valid domain name (has not registered.).

3) Operation

Before you use our quick DDNS, you need to enable this service and set proper server address, port value and domain name.

- Server address: www.quickddns.com
- Port number: 80
- Domain name: There are two modes: Default domain name and customized domain name. Except default domain name registration, you can also use customized domain name (You can input your self-defined domain name.). After successful registration, you can use domain name to login installed of the device IP.
- User name: It is optional. You can input your commonly used email address.

Important

- Do not register frequently. The interval between two registrations shall be more than 60 seconds. Too many registration requests may result in server attack.
- System may take back the domain name that is idle for one year. You can get a notification email before the cancel operation if your email address setup is OK.

4.6.5.7 UPNP

The UPNP protocol is to establish a mapping relationship between the LAN and the WAN. Please input the router IP address in the LAN in Figure 4-33. Double click the UPNP item in Figure 4-33, you can see the following interface. See Figure 4-40.

- UPNP on/off : Turn on or off the UPNP function of the device.
- Status: When the UPNP is offline, it shows as “Unknown”. When the UPNP works it shows “Success”
- Router LAN IP: It is the router IP in the LAN.
- WAN IP: It is the router IP in the WAN.
- Port Mapping list: The port mapping list here is the one to one relationship with the router’s port mapping setting.
- Enable Switch : : It shows that the function of port mapping is enabled in this port.
- List:
 - ◇ Service name: Defined by user.
 - ◇ Protocol: Protocol type
 - ◇ Internal port: Port that has been mapped in the router.
 - ◇ External port: Port that has been mapped locally.
- Default: UPNP default port setting is the HTTP, TCP and UDP of the NVR.
- Add to the list: Click it to add the mapping relationship.
- Delete: Click it to remove one mapping item.

Double click one item; you can change the corresponding mapping information. See Figure 4-41.

Important:

When you are setting the router external port, please use 1024~5000 port. Do not use well-known port 1~255 and the system port 256~1023 to avoid conflict.

For the TCP and UDP, please make sure the internal port and external port are the same to guarantee the proper data transmission.

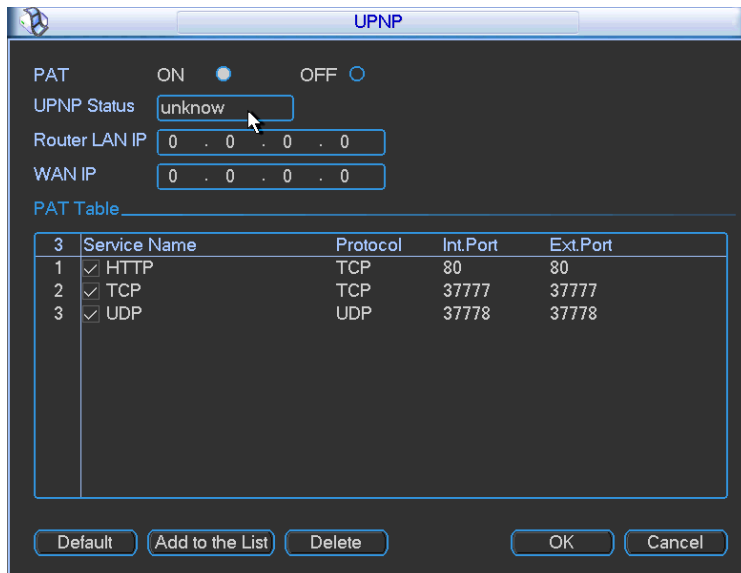

Figure 4-40

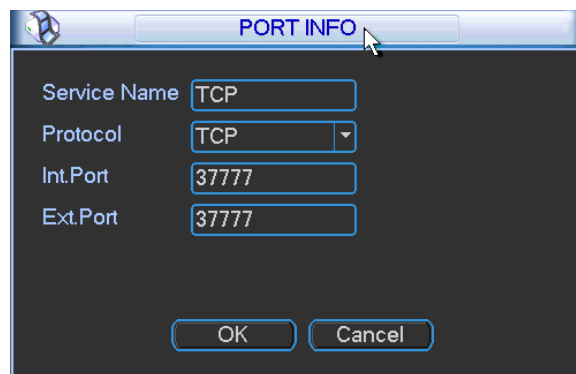

Figure 4-41

4.6.5.8 WIFI Setting

You can view the WIFI connection status in the Network Setting interface. See Figure 4-42. You can view current connection status and IP address if there is a connection.

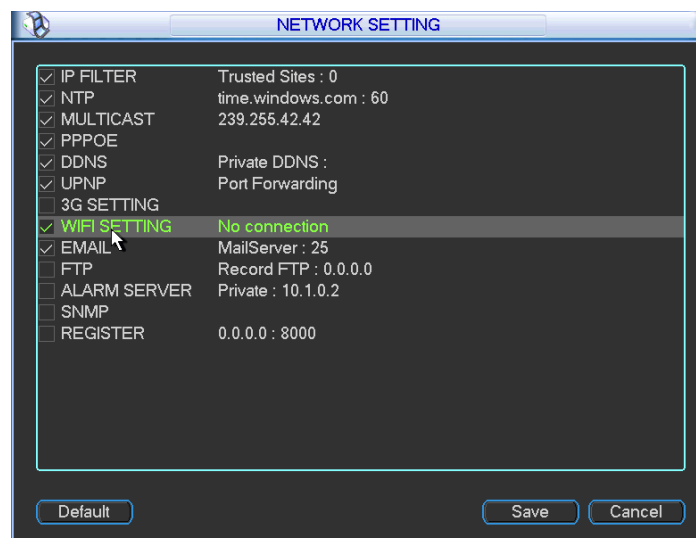

Figure 4-42

The WIFI interface is shown as below. See Figure 4-43.

- Auto connect WIFI: Check the box here, system automatically connects to the previous WIFI hotspot.
- Refresh: You can click it to search the hotspot list again. It can automatically add the information such as the password if you have set it before.
- Disconnect: Here you can click it to turn off the connection.
- Connect: Here you can click it to connect to the hotspot. System needs to turn off current connection and then connect to a new hotspot if there is connection of you selected one. See Figure 4-44.

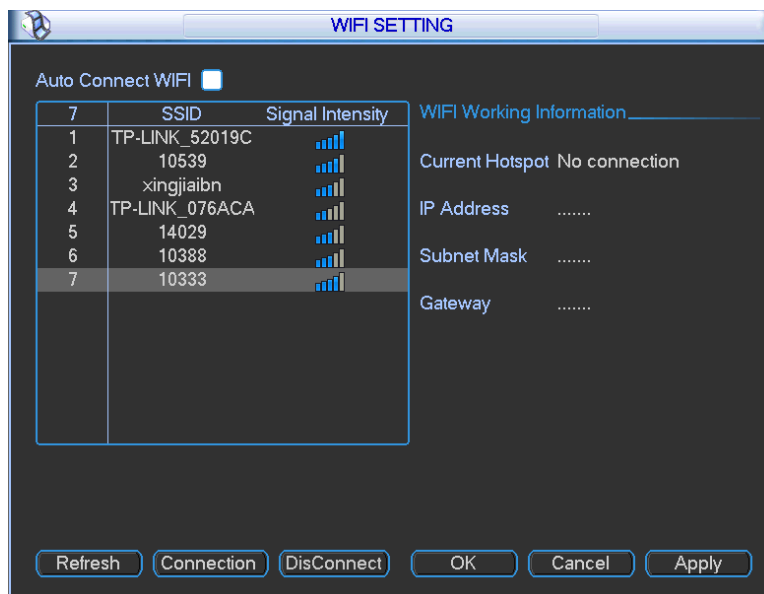

Figure 4-43



Figure 4-44

After successfully connection, you can see the following interface. You can see it is connected now. See Figure 4-45.

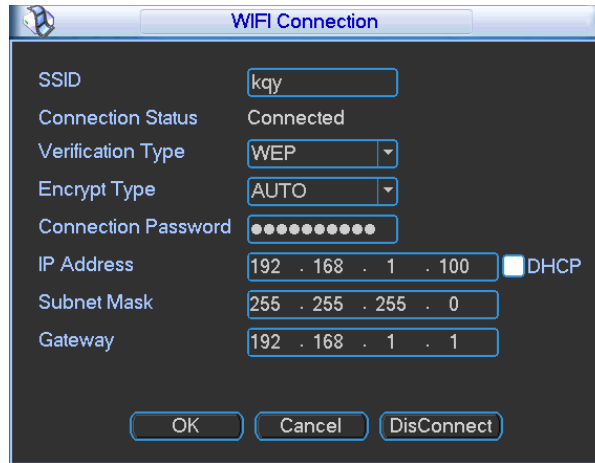

Figure 4-45

- WIFI working status: Here you can view current connection status.

Please note:

- After successful connection, you can see WIFI connection icon at the top right corner of the preview interface.
- When the hotspot verification type is WEP, system displays as AUTO since the device can not detect its encryption type.
- System does not support verification type WPA and WPA2. The display may become abnormal for the verification type and encryption type.

After device successfully connected to the WIFI, you can view the hotspot name, IP address, subnet mask, default gateway and etc. See Figure 4-46.

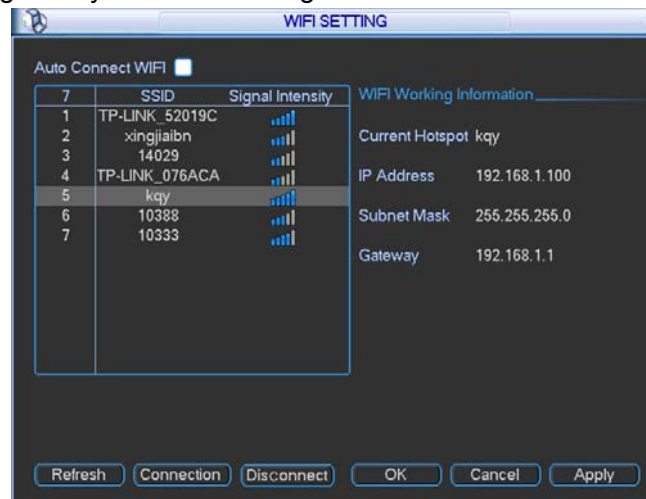

Figure 4-46

4.6.5.9 Email

The email interface is shown as below. See Figure 4-47.

- SMTP server: Please input your email SMTP server IP here.
- Port: Please input corresponding port value here.
- User name: Please input the user name to login the sender email box.
- Password: Please input the corresponding password here.
- Sender: Please input sender email box here.

- Title: Please input email subject here. System support English character and Arabic number. Max 32-digit.
- Receiver: Please input receiver email address here. System max supports 3 email boxes.
- SSL enable: System supports SSL encryption box.
- Interval: The send interval ranges from 0 to 3600 seconds. 0 means there is no interval.
- Health email enable: Please check the box here to enable this function. This function allows the system to send out the test email to check the connection is OK or not.
- Interval: Please check the above box to enable this function and then set the corresponding interval. System can send out the email regularly as you set here. Click the Test button, you can see the corresponding dialogue box to see the email connection is OK or not. See Figure 4-48.

Please note system will not send out the email immediately when the alarm occurs. When the alarm, motion detection or the abnormality event activates the email, system sends out the email according to the interval you specified here. This function is very useful when there are too many emails activated by the abnormality events, which may result in heavy load for the email server.

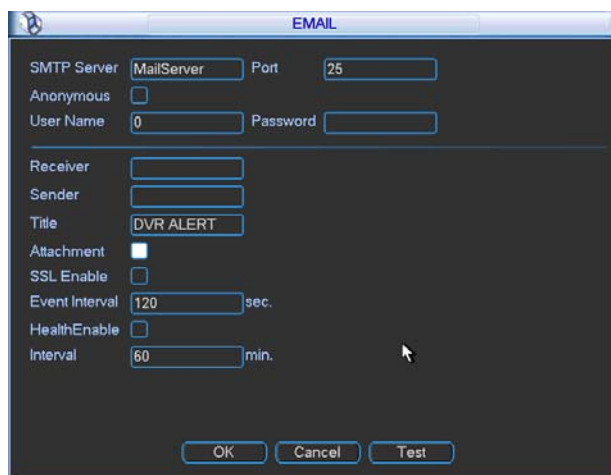

Figure 4-47

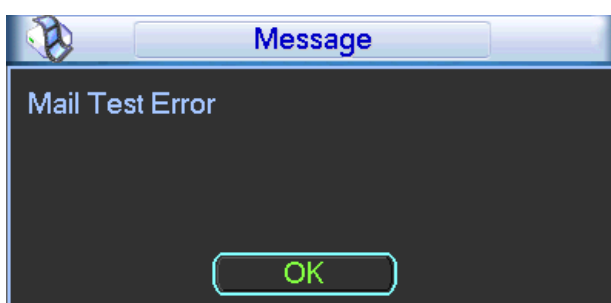

Figure 4-48

4.6.5.10 FTP

You need to download or buy FTP service tool (such as Ser-U FTP SERVER) to establish FTP service.

Please install Ser-U FTP SERVER first. From “start” -> “program” -> Serv-U FTP Server -> Serv-U Administrator. Now you can set user password and FTP folder. Please note you need to grant write right to FTP upload user. See Figure 4-49.

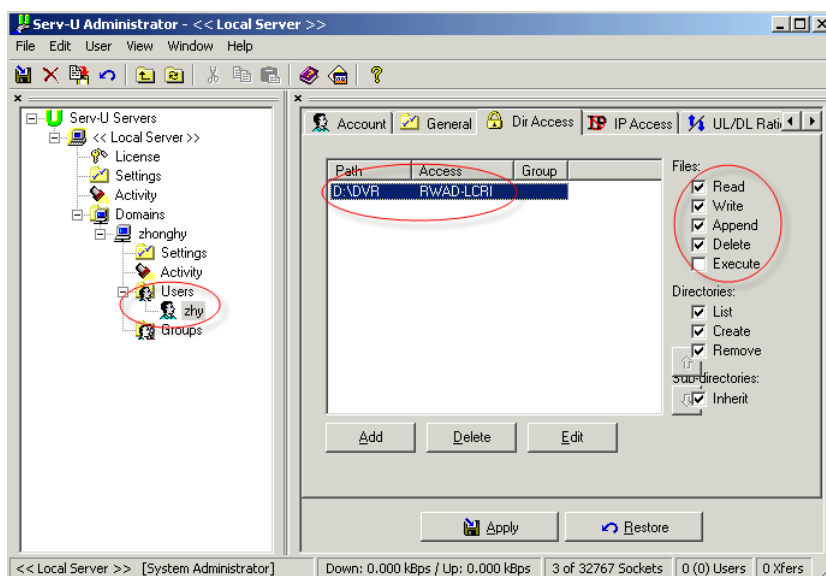

Figure 4-49

You can use a PC or FTP login tool to test setup is right or not.

For example, you can login user ZHY to [FTP://10.10.7.7](ftp://10.10.7.7) and then test it can modify or delete folder or not. See Figure 4-50.

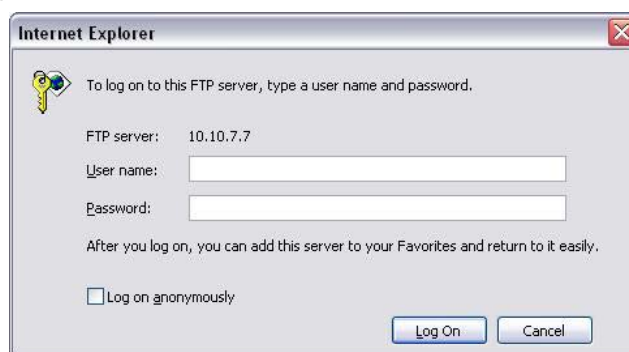

Figure 4-50

System also supports upload multiple NVRs to one FTP server. You can create multiple folders under this FTP.

In Figure 4-33, select FTP and then double click mouse. You can see the following interface. See Figure 4-51.

Please highlight the icon  in front of Enable to activate FTP function.

Here you can input FTP server address, port and remote directory. When remote directory is null, system automatically create folders according to the IP, time and channel.

User name and password is the account information for you to login the FTP.

File length is upload file length. When setup is larger than the actual file length, system will upload the whole file. When setup here is smaller than the actual file length, system only uploads the set length and auto ignore the left section. When interval value is 0, system uploads all corresponding files.

After completed channel and weekday setup, you can set two periods for one each channel.

Click the Test button, you can see the corresponding dialogue box to see the FTP connection is OK or not. See Figure 4-52.

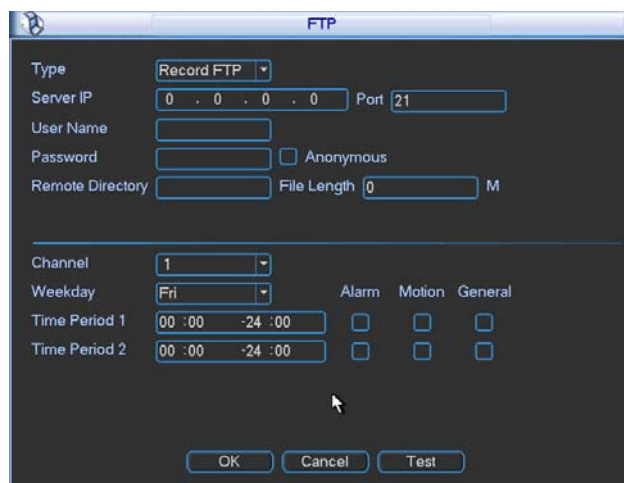

Figure 4-51

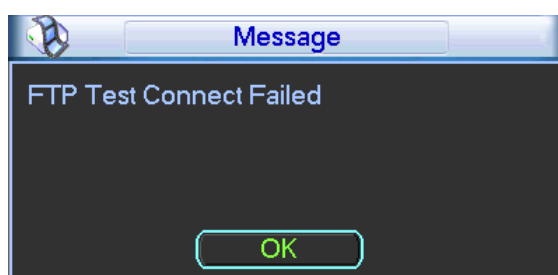

Figure 4-52

4.6.5.11 Alarm center

Interface is pre-reserved for the users to develop this function.

4.6.5.12 SNMP

SNMP is an abbreviation of Simple Network Management Protocol. It provides the basic network management frame of the network management system. The SNMP widely used in many environments. It is used in many network device, software and system.

You can set in the following interface. See Figure 4-53.

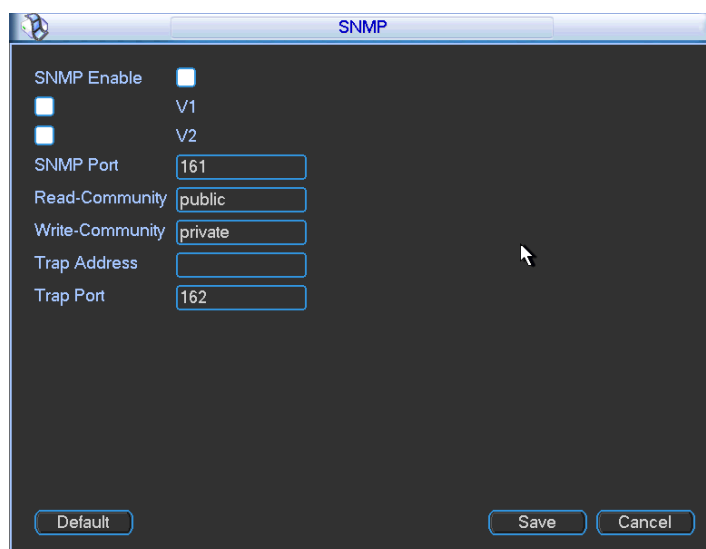

Figure 4-53

Please enable the SNMP function. Use the corresponding software tool (MIB Builder and MG-SOFT MIB Browser. You still need two MIB file: BASE-SNMP-MIB, NVR-SNMP-MIB) to connect to the device. You can get the device corresponding configuration information after successfully connection.

Please follow the steps listed below to configure.

- In Figure 4-53, check the box to enable the SNMP function. Input the IP address of the PC than is running the software in the Trap address. You can use default setup for the rest items.
- Compile the above mentioned two MIB file via the software MIB Builder.
- Run MG-SOFT MIB Browser to load the file from the previous step to the software.
- Input the device IP you want to manage in the MG-SOFT MIB Browser. Please set the corresponding version for your future reference.
- Open the tree list on the MG-SOFT MIB Browser; you can get the device configuration. Here you can see the device has how many video channels, audio channels, application version and etc.

4.6.5.13 Auto register

This function allows the device to auto register to the proxy you specified. In this way, you can use the client-end to access the NVR and etc via the proxy. Here the proxy has a switch function. In the network service, device supports the server address of IPv4 or domain.

Please follow the steps listed below to use this function.

Please set proxy server address, port, and sub-device name at the device-end. Please enable the auto register function, the device can auto register to the proxy server.

1) The setup interface is shown as in Figure 4-54.

Important

Do not input network default port such as TCP port number.

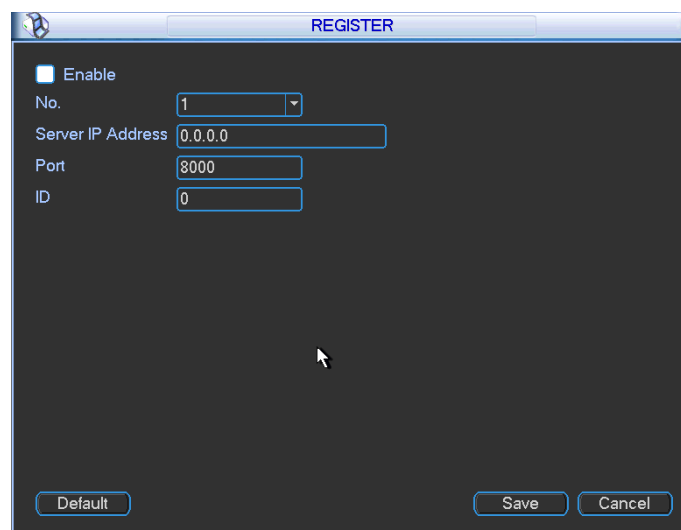

Figure 4-54

2) The proxy server software developed from the SDK. Please open the software and input the global setup. Please make sure the auto connection port here is the same as the port you set in the previous step.

3) Now you can add device. Please do not input default port number such as the TCP port in the mapping port number. The device ID here shall be the same with the ID you input in Figure 4-54. Click Add button to complete the setup.

4) Now you can boot up the proxy server. When you see the network status is Y, it means your registration is OK. You can view the proxy server when the device is online.

Important

The server IP address can also be domain. But you need to register a domain name before you run proxy device server.

4.6.6 Alarm

In the main menu, from Setting to Alarm, you can see alarm setup interface. See Figure 4-55.

- Alarm in: Here is for you to select channel number.
- Event type: There are four types. Local input/network input/IPC external/IPC offline alarm.
 - ✧ Local input alarm: The alarm signal system detects from the alarm input port.
 - ✧ Network input alarm: It is the alarm signal from the network.
 - ✧ IPC external alarm: It is the on-off alarm signal from the front-end device and can activate the local NVR.
 - ✧ IPC offline alarm: Once you select this item, system can generate an alarm when the front-end IPC disconnects with the local NVR. The alarm can activate record, PTZ, snap and etc. The alarm can last until the IPC and the NVR connection resumes.
- Enable: Please you need to highlight this button to enable current function.
- Type: normal open or normal close.
- Period: It is to set local alarm period. System only enables local alarm in the specified period. Click the Set button; you can select the business day and the non-business day. Please note for the work day/free day setup and the specific work day setup, system just saves the latest setup. For example, the work day ranges from 8:30-17:30 Monday to Friday, and then you set the period 7:10-18:00 for Monday. So, the arm period of the Monday ranges from 7:10 to 18:00. Please highlight the corresponding button to enable this function.
- PTZ activation: When an alarm occurred, system can activate the PTZ operation. The PTZ activation lasts an anti-dither period.
 - ✧ In the Pan/Tilt/Zoom interface (Main menu->Setting-> Pan/Tilt/Zoom), please set video channel, speed dome protocol and etc.
 - ✧ Select the channel of current speed dome as current monitor video and the right click mouse to select Pan/Tilt/Zoom item. Now you can set preset, tour pattern.
 - ✧ In Figure 4-56, click “select” button, you can see an interface is shown as in Figure 4-57. Here you can set the activation operation such as preset tour, pattern and enable.
- Anti-dither: Here you can set anti-dither time. The value ranges from 5 to 600s. The anti-dither time refers to the alarm signal lasts time. It can be seem as the alarm signal activation stays such as the buzzer, tour, PTZ activation, snapshot, channel record. The stay time here does not include the latch time. During the alarm process, the alarm signal can begin an anti-dither time if system detects the local alarm again. The screen prompt, alarm upload, email and etc will not be activated. For example, if you set the anti-dither time as 10 second, you can see the each activation may last 10s if the local alarm is activated. During the process, if system detects another local alarm signal at the fifth second, the buzzer, tour, PTZ activation, snapshot, record channel will begin another 10s while the screen prompt, alarm upload, email will not be activated again. After 10s, if system detects another alarm signal, it can generate an alarm since the anti-dither time is out.

- Alarm output: The number here is the device alarm output port. You can select the corresponding ports(s) so that system can activate the corresponding alarm device(s) when an alarm occurred.
- Latch: When the anti-dither time ended, the channel alarm you select in the alarm output may last the specified period. The value ranges from 1 to 300 seconds. This function is not for other alarm activation operations. The latch is still valid even you disable the alarm event function directly.
- Show message: System can pop up a message to alarm you in the local host screen if you enabled this function.
- Alarm upload: System can upload the alarm signal to the network (including alarm centre and the WEB) if you enabled current function. System only uploads the alarm channel status. You can go to the WEB and then go to the Alarm interface to set alarm event and alarm operation. Please go to the Network interface to set alarm centre information.
- Send email: System can send out the alarm signal via the email to alert you when alarm occurs. Once you enable the snap function, system can also send out an image as the attachment. Please go to the Main Menu->Setting ->Network->Email interface to set.
- Record channel: you can select proper channel to record alarm video (Multiple choices).
 - ✧ You need to set alarm record mode as Schedule in Record interface (Main Menu->Advanced->Record). Please note the manual record has the highest priority. System record all the time no matter there is an alarm or not if you select Manual mode.
 - ✧ Now you can go to the Schedule interface (Main Menu->Setting->Schedule) to set the record type, corresponding channel number, week and date. You can select the record type:Regular/MD/Alarm/MD&Alarm. Please note, you can not select the MD&Alarm and MD(or Alarm) at the same time.
 - ✧ Now you can go to the Encode interface to select the alarm record and set the encode parameter (Main Menu->Setting->Encode).
 - ✧ Finally, you can set the alarm input as the local alarm and then select the record channel. The select channel begins alarm record when an alarm occurred. Please note system begins the alarm record instead of the MD record if the local alarm and MD event occurred at the same time.
- Tour: Here you can enable tour function when an alarm occurs. System supports 1/8-window tour. Please go to chapter 4.6.9 Display for tour interval setup. Please note the tour setup here has higher priority than the tour setup you set in the Display interface. Once there two tours are both enabled, system can enable the alarm tour as you set here when an alarm occurred. If there is no alarm, system implements the tour setup in the Display interface.
- Snapshot: You can enable this function to snapshot image when an alarm occurs.
- Buzzer: Highlight the icon to enable this function. The buzzer beeps when an alarm occurs.

Please highlight icon  to select the corresponding function. After setting all the setups please click save button, system goes back to the previous menu.

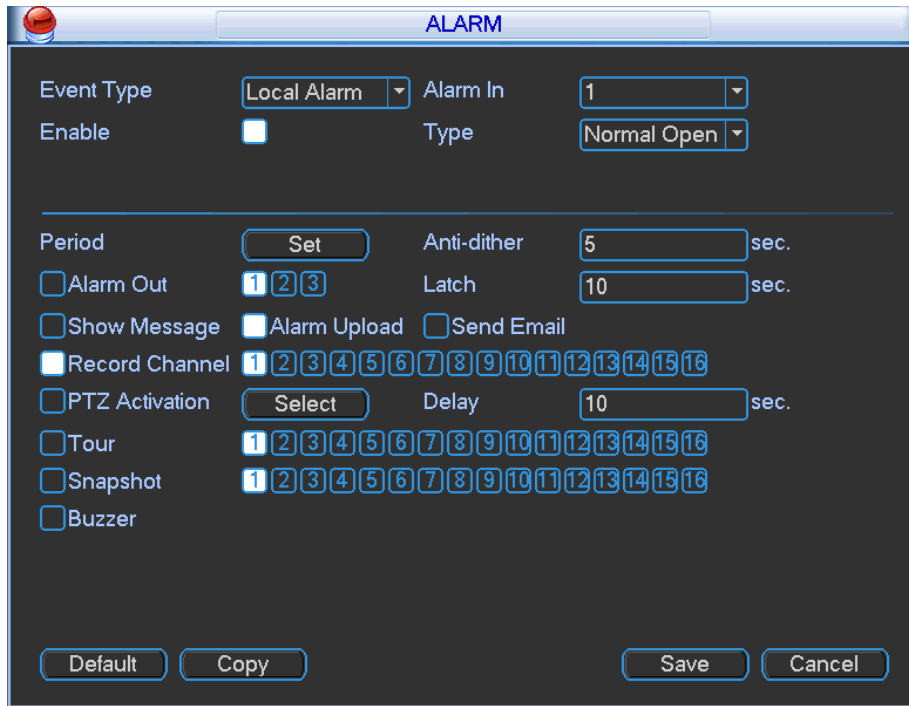

Figure 4-55



Figure 4-56

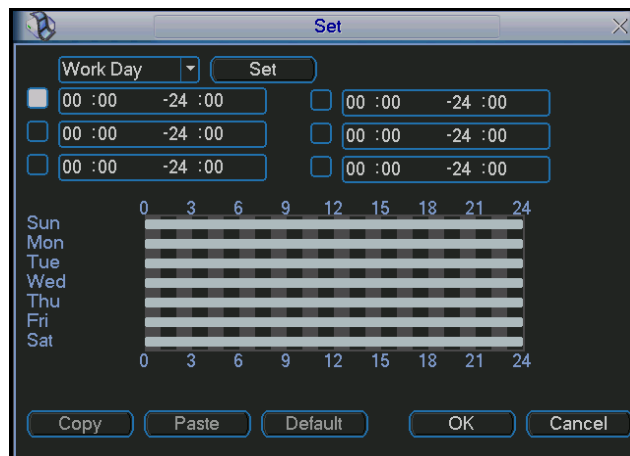

Figure 4-57

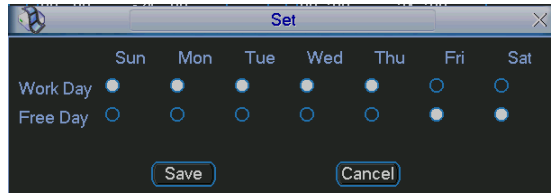

Figure 4-58

For the 32-channel series product, the alarm interface and PTZ setup is shown as below. See Figure 4-59 and Figure 4-60.

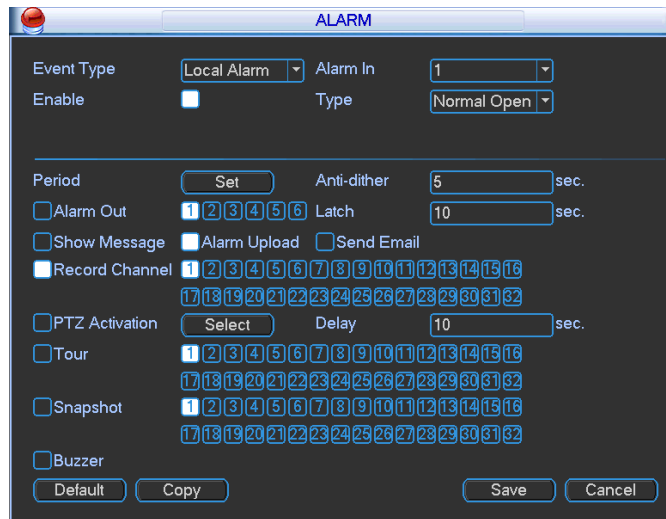

Figure 4-59

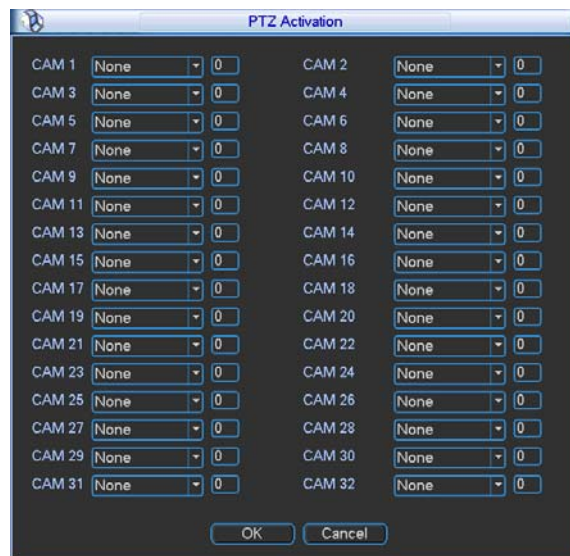

Figure 4-60

4.6.7 Detect

Go to Detect Menu

In the main menu, from Setting to Detect, you can see motion detect interface. See Figure 4-61. There are three detection types: motion detection, video loss, camera masking.

- The video loss has no detection region and sensitivity setup and camera masking has no

detection region setup.

- You can see motion detect icon if current channel has enabled motion detect alarm.
- You can drag you mouse to set motion detect region without Fn button. Please click OK button to save current region setup. Right click mouse to exit current interface.

4.6.7.1 Motion Detect

Detection menu is shown as below. See Figure 4-61.

- Event type: From the dropdown list you can select motion detection type.
- Channel: Select a channel from the dropdown list to set motion detect function.
- Enable: Check the box here to enable motion detect function.
- Region: Click select button, the interface is shown as in Figure 4-62. Here you can set motion detection zone. There are 396(PAL)/330(NTSC) small zones. The green zone is current cursor position. Grey zone is the motion detection zone. Black zone is the disarmed zone. You can click Fn button to switch between the arm mode and disarm mode. In arm mode, you can click the direction buttons to move the green rectangle to set the motion detection zone. After you completed the setup, please click ENTER button to exit current setup. Do remember click save button to save current setup. If you click ESC button to exit the region setup interface system will not save your zone setup.
- Sensitivity: System supports 6 levels. The sixth level has the highest sensitivity.
- Period: Click set button, you can see an interface is shown as in Figure 4-64. Here you can set for business day and non-business day. In Figure 4-64 click set button, you can see an interface is shown as in Figure 4-65. Here you can set your own setup for business day and non-business day.
- Alarm output: when an alarm occurs, system enables peripheral alarm devices.
- Latch: when motion detection complete, system auto delays detecting for a specified time. The value ranges from 1-300(Unit: second)
- Show message: System can pop up a message to alarm you in the local host screen if you enabled this function.
- Alarm upload: System can upload the alarm signal to the network (including alarm centre) if you enabled current function.
- Send email: System can send out email to alert you when an alarm occurs.
- Record channel: Select the channel to activate recording function once an alarm occurred. Please make sure you have set MD record in encode interface(Main Menu->Setting->Schedule) and schedule record in manual record interface(Main Menu->Advanced->Manual Record)
- PTZ activation: Here you can set PTZ movement when an alarm occurs. System can go to a preset, when there is an alarm. Click “select” button, you can see an interface is shown as in Figure 4-63.
- Record Delay: System can delay the record for specified time after alarm ended. The value ranges from 10s to 300s.
- Tour: Here you can enable tour function when an alarm occurs. System one-window tour. Please go to chapter 5.3.9 Display for tour interval setup.
- Snapshot: You can enable this function to snapshot image when motion detect alarm occurs.

Please highlight icon  to select the corresponding function. After all the setups please click

save button, system goes back to the previous menu.

Note:

In motion detection mode, you can not use copy/paste to set channel setup since the video in each channel may not be the same.

In Figure 4-62, you can left click mouse and then drag it to set a region for motion detection. Click Fn to switch between arm/withdraw motion detection. After setting, click enter button to exit.

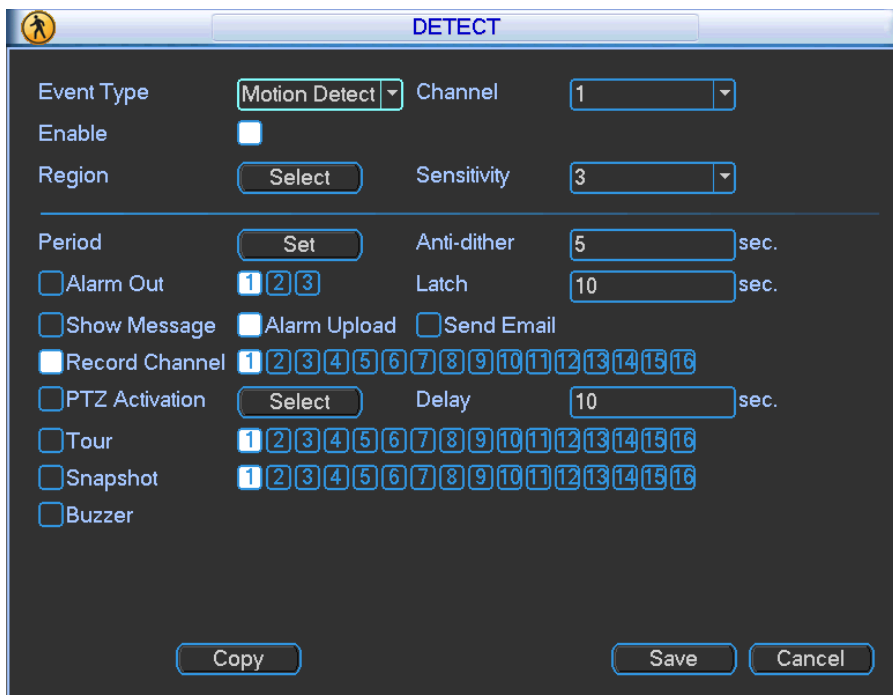

Figure 4-61

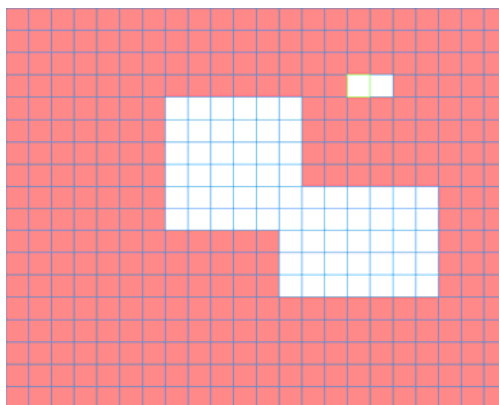

Figure 4-62



Figure 4-63

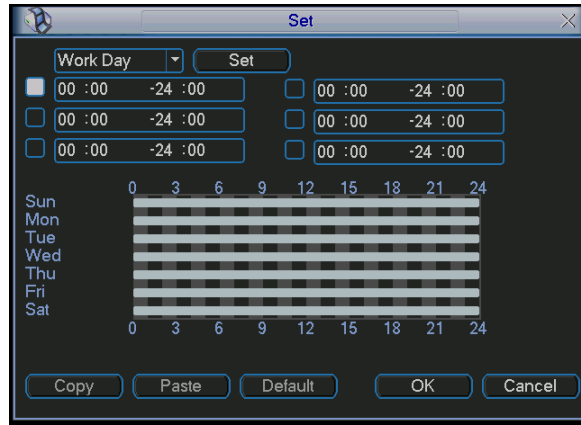

Figure 4-64

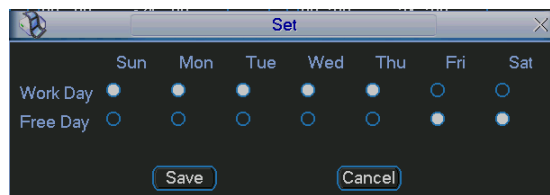

Figure 4-65

4.6.7.2 Video Loss

In Figure 4-61, select video loss from the type list. You can see the interface is shown as in Figure 4-66. This function allows you to be informed when video loss phenomenon occurred. You can enable alarm output channel and then enable show message function. You can refer to chapter 4.6.7.1 Motion detect for detailed information.

Tips:

You can enable preset/tour/pattern activation operation when video loss occurs.

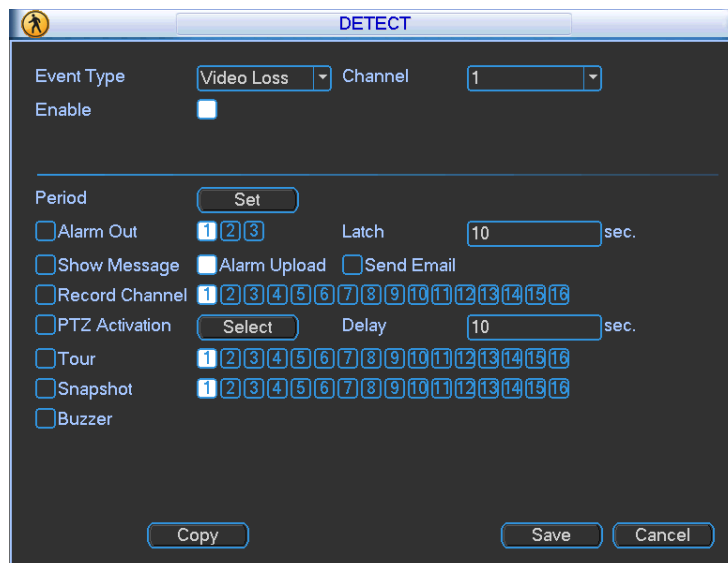

Figure 4-66

4.6.7.3 Camera Masking

When someone viciously masks the lens, or the output video is in one-color due to the

environments light change, the system can alert you to guarantee video continuity. Camera masking interface is shown as in Figure 4-67. You can enable alarm output channel and then enable show message function. You can refer to chapter 4.6.7.1 Motion detect for detailed information.

Tips:

You can enable preset/tour/pattern activation operation when video loss occurs.

Note:

In Detect interface, copy/paste function is only valid for the same type, which means you can not copy a channel setup in video loss mode to camera masking mode.

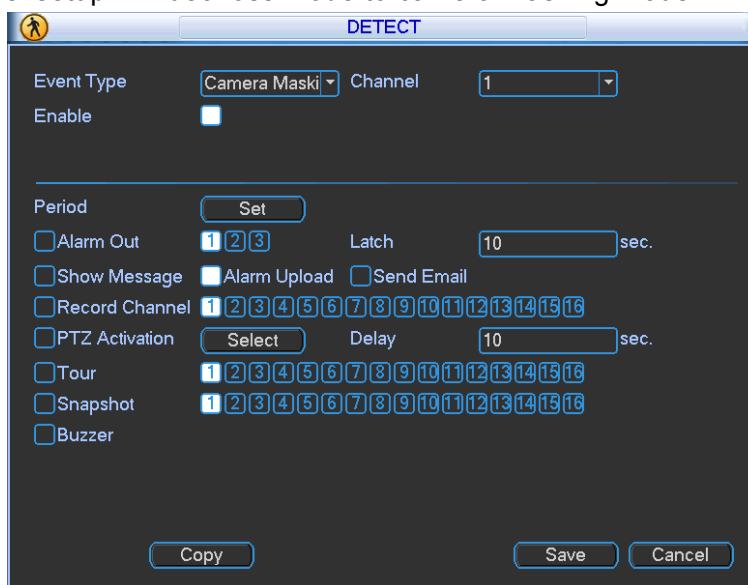

Figure 4-67

4.6.8 PTZ

Note: All the operations here are based on PELCOD protocol. For other protocols, there might be a little difference.

Cable Connection

Please follow the procedures below to go on cable connection

- Connect the dome RS485 port to NVR 485 port.
- Connect dome video output cable to NVR video input port.
- Connect power adapter to the dome.

PTZ Setup

Note: The camera video should be in the current screen. Before setup, please check the following connections are right:

- PTZ and decoder connection is right. Decoder address setup is right.
- Decoder A (B) line connects with NVR A (B) line.

Boot up the NVR, input user name and password.

In the main menu, click setting, and then click Pan/Tilt Control button. The interface is shown as in Figure 4-68. Here you can set the following items:

- Channel: Select the current camera channel.
- PTZ type: There are two types: local/remote.
- Protocol: Select corresponding PTZ protocol(such as PELCOD)

- Address: Default address is 1.
- Baud rate: Select corresponding baud rate. Default value is 9600.
- Data bit: Select corresponding data bits. Default value is 8.
- Stop bit: Select corresponding stop bits. Default value is 1.
- Parity: There are three options: odd/even/none. Default setup is none.

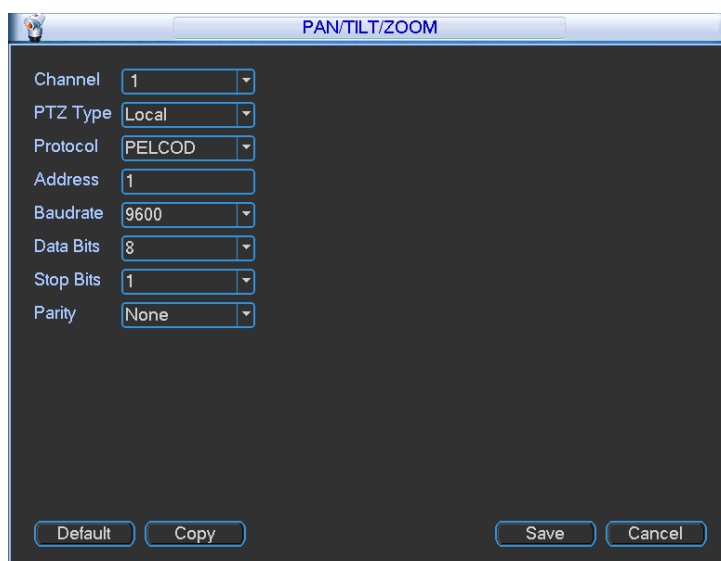

Figure 4-68

If you are connecting to network PTZ, the PTZ type shall be remote. See Figure 4-69.

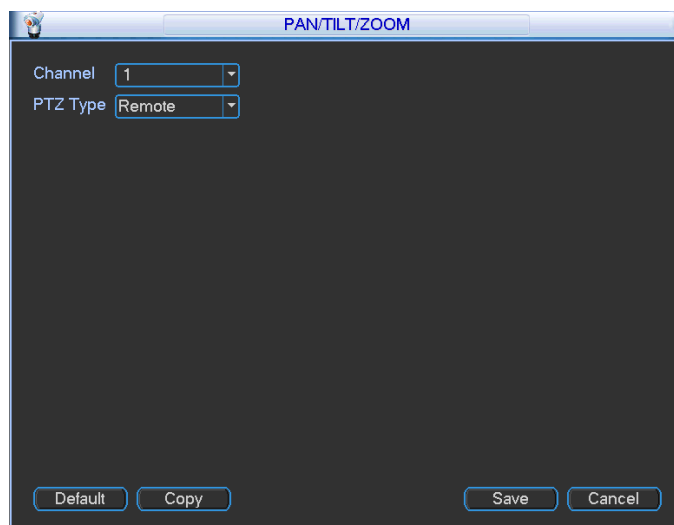

Figure 4-69

After completing all the setting please click save button.

In one window display mode, right click mouse (click "Fn" Button in the front panel or click "Fn" key in the remote control).

Click Pan/Tilt/Zoom, the interface is shown as below. See Figure 4-70.

Here you can set the following items:

- Step: value ranges fro 1 to 8.
- Zoom
- Focus
- Iris

Please click icon  and  to adjust zoom, focus and iris.











Figure 4-70

In Figure 4-70, please click direction arrows to adjust PTZ position. There are total 8 direction arrows.





Figure 4-71

Here is a sheet for you reference.

Name	Function key	function	Shortcut key	Function key	function	Shortcut Key
Zoom		Wide			Far	
Focus		Near			Far	
Iris		Close			Open	

4.6.9 Display

Display setup interface is shown as below. See Figure 4-72.

- Transparency: Here is for you to adjust transparency. The value ranges from 128 to 255.
- Channel name: Here is for you to modify channel name. System max support 25-digit (The value may vary due to different series). Please note all your modification here only applies to NVR local end. You need to open web or client end to refresh channel name.
- Time display: You can select to display time or not when system is playback.
- Channel display: You can select to channel name or not when system is playback.
- Resolution: There are four options: 1280×1024(default),1280×720,1024×768,800×600. Please note the system needs to reboot to activate current setup.
- Enable tour: Activate tour function.
- Interval: System supports 1/4/8/9/16-window tour. Input proper interval value here. The value ranges from 5-120 seconds. In tour process, you can use mouse or click Shift to turn on window switch function.  Stands for opening switch function,  stands for closing switch function.
- Monitor tour type: System support 1/8-window tour.
- Alarm tour type: System support 1/8-window tour.

Please highlight icon  to select the corresponding function.

After completing all the setups please click save button, system goes back to the previous menu.

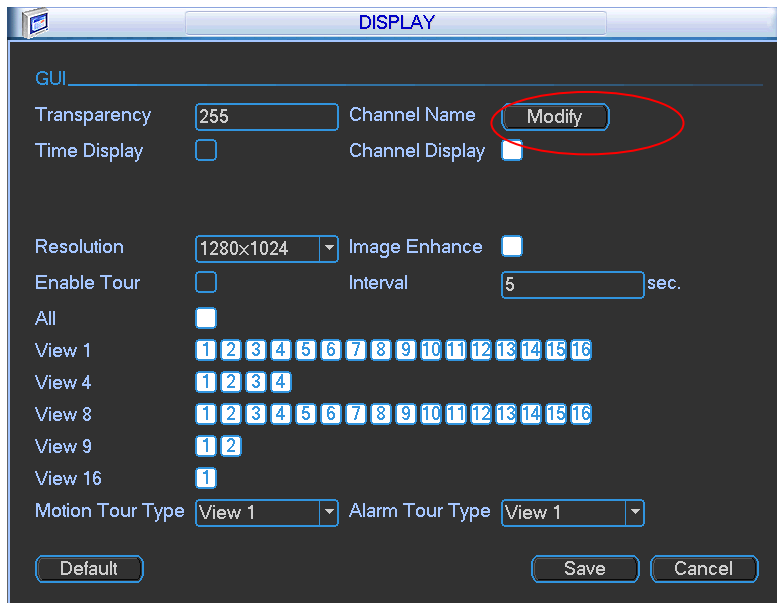



Figure 4-72

In Figure 4-72, click modify button after channel. You can see an interface shown as in Figure 4-73. Please note all your modification here applies to local end only. You need to refresh web or client-end to get the latest channel name. System max support 25-digital character.



Figure 4-73

4.6.10 Default

Click default icon, system pops up a dialogue box. You can highlight  to restore default factory setup.

- Select all
- General
- Encode
- Schedule
- RS232
- Network
- Alarm
- Detect
- Pan/tilt/zoom

- Display
- Channel name

Please highlight icon  to select the corresponding function.

After all the setups please click OK button, system goes back to the previous menu.

Warning!

System menu color, language, time display mode, video format, IP address, user account will not maintain previous setup after default operation!

4.6.11 Remote Device

Important

Do not connect the switch to the PoE port, otherwise the connection may fail!

4.6.11.1 UPNP

Please connect the IPC to the PoE port of the device rear panel (Figure 4-74), system can auto connect to the network camera. Please note the following figure is for reference only.

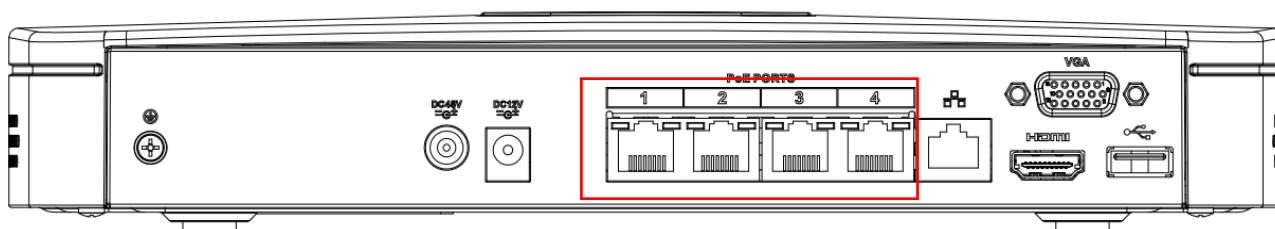

Figure 4-74

4.6.11.2 Built-in Switch Setup

The built-in switch function is for product of PoE port.

From Network->Network Server->Switch, you can set switch IP address, subnet mask, gateway and etc. See Figure 4-75.

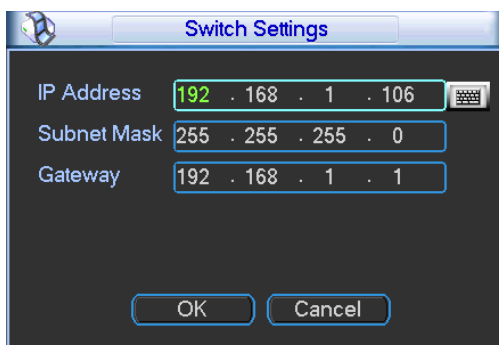

Figure 4-75

4.6.11.3 Remote Device

In the main menu, click the Remote Device icon to go to the corresponding interface. See Figure 4-76.



Figure 4-76

The remote device interface is shown as in Figure 4-77.

- IP search: Click it to search IP address.
- Add: Click it to connect to the selected device and add it to the Added device list. Support Batch add.
- Show filter: You can use it to display the specified devices from the added device.
- IPC config: Double click the  on the IPC config column, you can go to the IPC setup interface. See Figure 4-78.
 - ✧ Gain mode: It is to set video noise. Check Auto, system automatically sets video gain. Check Manual, you can set gain threshold, brightness and etc.
 - ✧ Gain threshold: Here is for you to set gain value. The different series product has different default values. The lower the value is, the lower the noise is. But the video brightness may become too dark under the low illumination. If the value is high, it can enhance the video brightness under the low illumination, but the video noise may become high.
 - ✧ BLC: Check the box here to enable backlight compensation function. System can automatically expose according to environment so that you can view the darkest section of the video.
 - ✧ Day/Night mode: Here is to set video color or black and white mode.
 - a) Color: Camera only outputs color video.
 - b) Auto: Camera auto selects color or black and white video according to device feature (Video whole brightness or there is any IR light or not.).
 - c) Black and white: Camera only outputs black and white video.
 - ✧ Exposure mode:
 - a) Auto: The video whole brightness can adjust automatically within the normal exposure threshold according to different environments. The lower the gain value is, the smaller the noise is.
 - b) Manual: It is to display manual exposure value.
- Delete: Please select one device in the Added device list and then click it to remove.
- Manual add: Click it to add the IPC manually. The port number is 37777. The default user name is **admin** and password is **admin**.

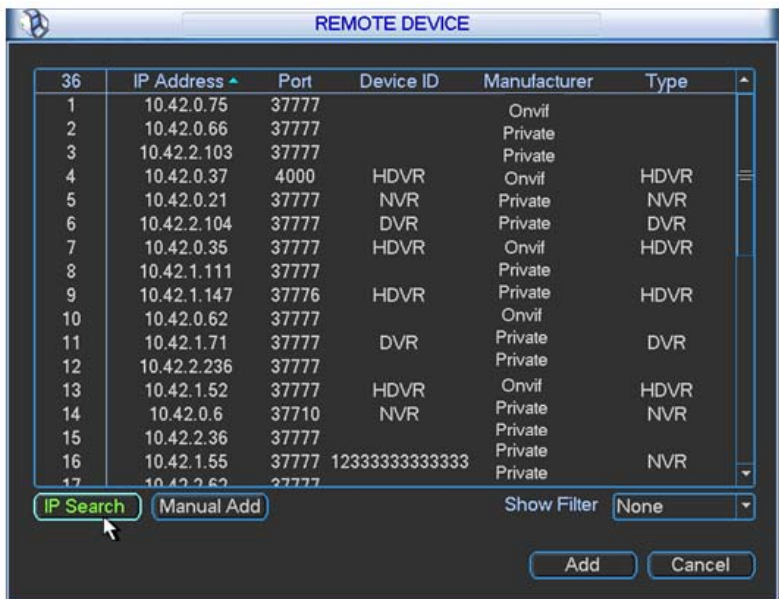

Figure 4-77

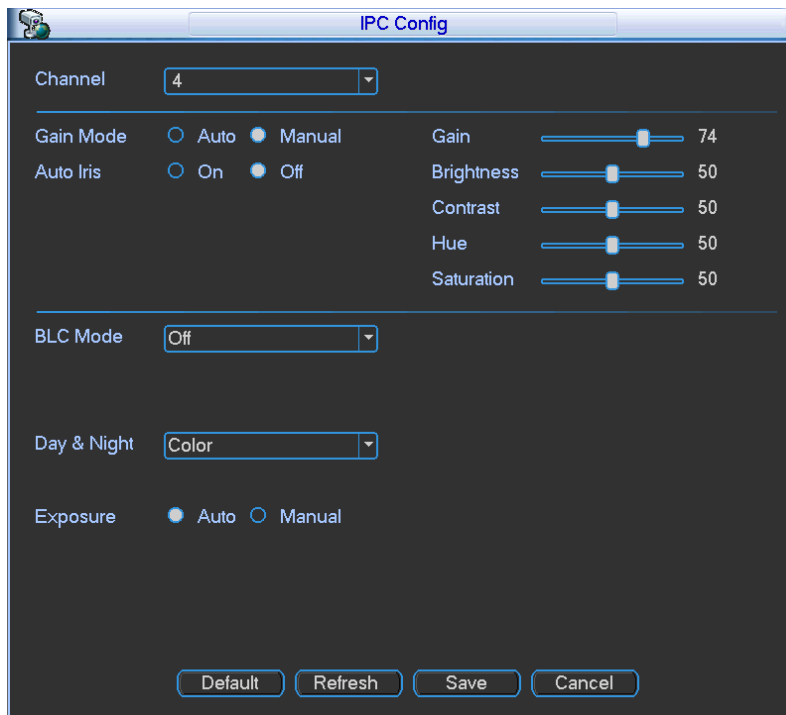

Figure 4-78

Click the Manual Add button; you can go to the following interface. See Figure 4-79.

This series product max supports 32-channel standard definition video/high definition non-real-time video and the transmission rate is 1Mbps per channel. It can also max supports 4-channel high definition video and the transmission rate is 8Mbps. The delay time of each channel is below 500ms.

Model	System Performance
4-ch series	Max support 4-channel video.

	Total resources:400/480fps@D1,200/240fps@720P.100/120@1080P.
8-ch series	Max support 8-channel video. Total resources:400/480fps@D1,200/240fps@720P.100/120@1080P.
16-ch series	Max support 16-channel video. Total resources:400/480fps@D1,200/240fps@720P.100/120@1080P.
32-ch series	Max support 32-channel standard definition video. Support 8-channel 1080p/5Mbps (extra stream D1/1Mbps), 16-channel 720p/2Mbps (extra CIF/640kbps), 32-channel D1/1Mbps.

This series product supports the IPC from many popular manufactures such as Sony, Hitachi, dynacolor, Axis, Samsung, arecont, Dahua, onvif and custom type. You can just input URL address, user name, and password to login the front-end device.

In the following interface, you can see there are three connection modes: auto, TCP (default), UDP.

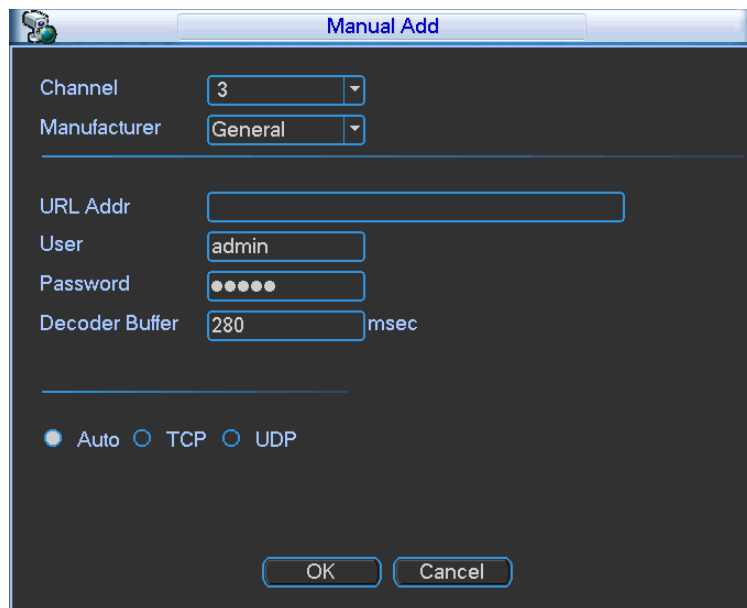

Figure 4-79

4.6.11.4 Short-cut Menu

In the preview interface, for the channel of no IPC connection, you can click the icon “+” in the centre of the interface to quickly go to the Remote Device interface. See Figure 4-80 and Figure 4-81.



Figure 4-80

REMOTE DEVICE

36	IP Address ^	Port	Device ID	Manufacturer	Type
1	10.42.0.75	37777		Onvif	
2	10.42.0.66	37777		Private	
3	10.42.2.103	37777		Private	
4	10.42.0.37	4000	HDVR	Onvif	HDVR
5	10.42.0.21	37777	NVR	Private	NVR
6	10.42.2.104	37777	DVR	Private	DVR
7	10.42.0.35	37777	HDVR	Onvif	HDVR
8	10.42.1.111	37777		Private	
9	10.42.1.147	37776	HDVR	Private	HDVR
10	10.42.0.62	37777		Onvif	
11	10.42.1.71	37777	DVR	Private	DVR
12	10.42.2.236	37777		Private	
13	10.42.1.52	37777	HDVR	Onvif	HDVR
14	10.42.0.6	37710	NVR	Private	NVR
15	10.42.2.36	37777		Private	
16	10.42.1.55	37777	12333333333333	Private	NVR
17	10.42.2.62	37777		Private	

IP Search Manual Add Show Filter None Add Cancel

Figure 4-81

4.7 Advanced

Double click advanced icon in the main window, the interface is shown as below. See Figure 4-82. There are total eight function keys: HDD management, alarm output, abnormality, manual record, account, auto maintenance, TV adjust and video matrix.

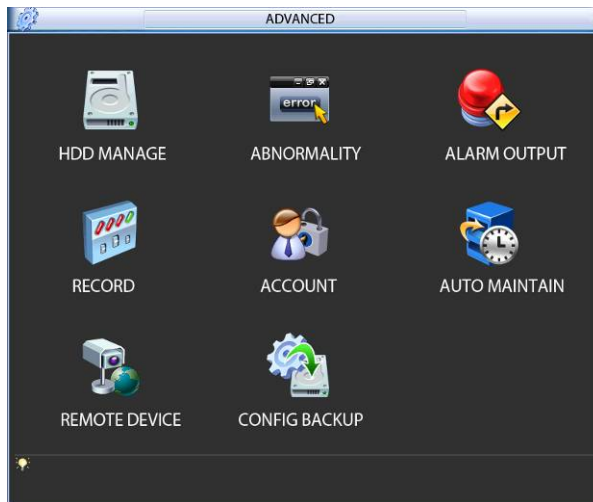

Figure 4-82

4.7.1 HDD Management

Here is for you to view and implement hard disk management. See Figure 4-83.

You can see current HDD type, status, capacity and record time. When HDD is working properly, system is shown as O. When HDD error occurred, system is shown as X.

- Alarm set: Click alarm set button, the interface is shown as below. See Figure 4-84. (This interface is just like the abnormality setup). Please refer to chapter 4.7.2 for detailed information.
- HDD operation: You can select HDD mode from the dropdown list such as read-only or you can erase all data in the HDD. Please note system needs to reboot to get all the modification activated.

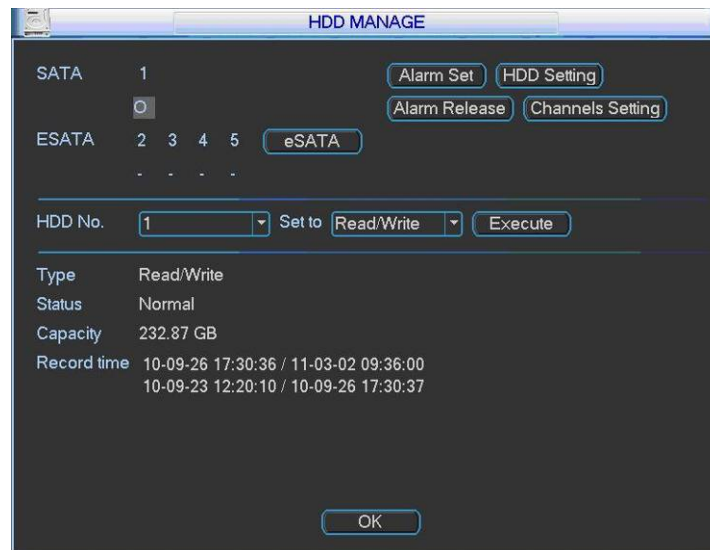

Figure 4-83

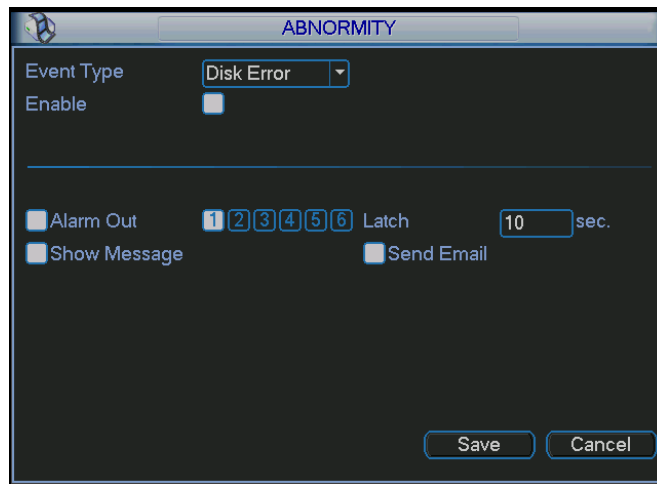

Figure 4-84

For the HDD group setup operation, please note:

- Each channel's records can be stored into the specified HDD Group.
- Each HDD Group is corresponding to several hard disks, while one hard disk is only included in one HDD Group.
- Each channel is only corresponding with one HDD Group, while one HDD Group can store records from several channels.
- HDD Group is only available for read-write HDD and self-defined disks, other types of hard disks cannot be set as HDD Group.

Important:

- eSATA also supports this function, you can manage e-SATA hard disk as local hard disk.
- Current series software version can only set the HDD group operation of the read-write HDDs. It is not for the redundancy HDD.

HDD Setting

Click the button "HDD Settings" at the top right corner of the Figure 4-83, system will pop up an interface as below. See Figure 4-85.

The number of hard disk from 1 to 2 is shown in the "HDD No." column (It is to show the max HDD amount you can install). If serial number is highlighted, it means this interface have access to the hard disk, otherwise it does not have access to the hard disk.

The "HDD Group" column lists the HDD Group number of current hard disk. You can select HDD group name from the dropdown list and then click Save button.

Please note, one HDD is corresponding to one group, while one group can have many HDDs. The HDD group No. is corresponding HDD port, the HDD group No. may vary if you change the HDD.

Important

Once you change the HDD Group settings, system will pack the records and snapshots, and then reboot.

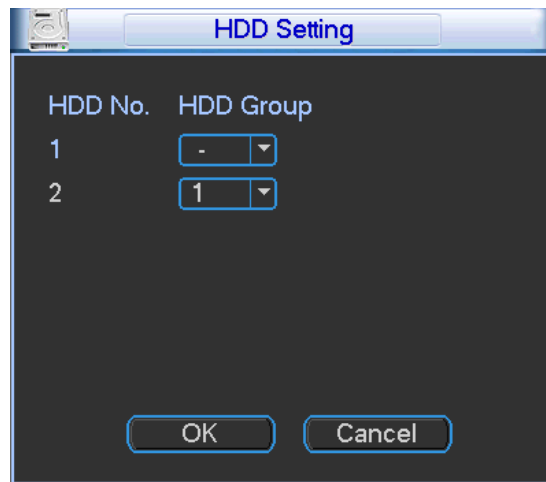

Figure 4-85

Channels Setting

Click the button named with “Channels Settings” at the top right corner of the Figure 4-83, system will pop up an interface shown as in Figure 4-86.

You can set HDDs for main stream, extra stream and snap pictures respectively. The main stream and extra stream of one channel can be saved to different groups.

Channel: It is to display the actual channel number of current NVR.

HDD Group: It is the SN of the HDD group management. For example, if you set two HDD groups such as Group 1 and Group 2, you can see there are two options (1/2) of the HDD group dropdown list.

Important

- Please make sure you have set HDD group for each channel, otherwise you can not save current setup!
- Once you change the HDD Group settings, system will pack the records and then reboot!

Tips

There is an easy way for you to test whether the records from the corresponding channel is saved in the specified HDD. You can remove the HDD and then check the channel can record or not. You can see the channel does not record and you can not search the previous record now.



Figure 4-86

4.7.2 Abnormality

Abnormality interface is shown as in Figure 4-87.

- Event type: There are several options for you such as disk error, no disk, disconnection, IP conflict and etc.
- Alarm output: Please select alarm activation output port (multiple choices).
- Latch: Here you can set corresponding delaying time. The value ranges from 10s-300s. System automatically delays specified seconds in turning off alarm and activated output after external alarm cancelled.
- Show message: system can pop up the message in the local screen to alert you when an alarm occurs.
- Alarm upload: System can upload the alarm signal to the network (including alarm centre) if you enabled current function.
- Send email: System can send out email to alert you when an alarm occurs.
- Buzzer: Highlight the icon to enable this function. The buzzer beeps when an alarm occurs.

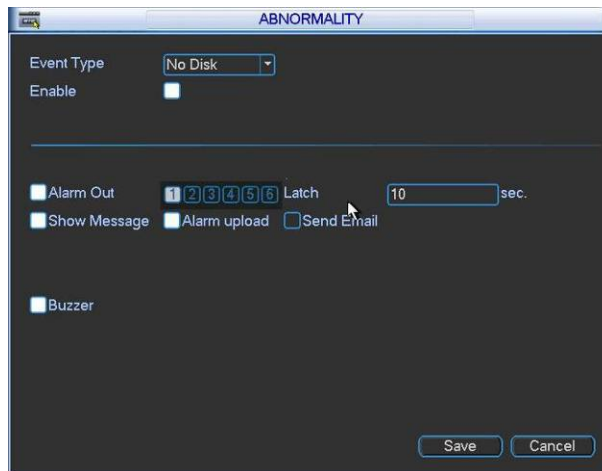

Figure 4-87

4.7.3 Alarm Output

Here is for you to set proper alarm output.

Please highlight icon  to select the corresponding alarm output.

After all the setups please click OK button, system goes back to the previous menu. See Figure 4-88.

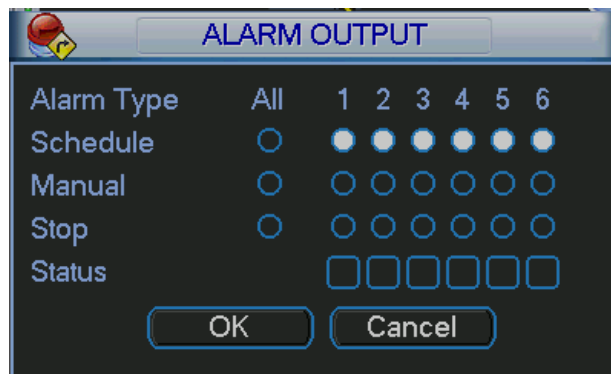

Figure 4-88

4.7.4 Manual Record

Note:

You need to have proper rights to implement the following operations. Please make sure the HDD has been properly installed.

4.7.4.1 Manual record menu

Right click mouse or in the main menu, Advanced->Manual Record.

Manual record menu is shown as in Figure 4-89.

4.7.4.2 Basic operation

There are three statuses: schedule/manual/stop. Please highlight icon “○” to select corresponding channel.

- Manual: The highest priority. After manual setup, all selected channels will begin ordinary recording.
- Schedule: Channel records as you have set in recording setup (Main Menu->Setting->Schedule)
- Stop: All channels stop recording.

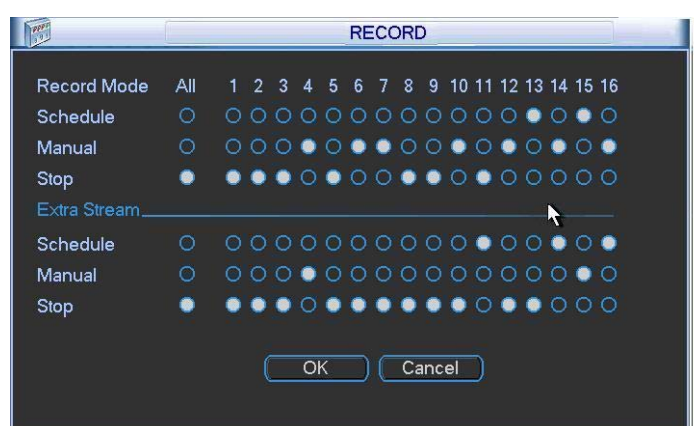

Figure 4-89

4.7.4.3 Enable/disable record

Please check current channel status: “○” means it is not in recording status, “●” means it is in recording status.

You can use mouse or direction key to highlight channel number. See Figure 4-90.

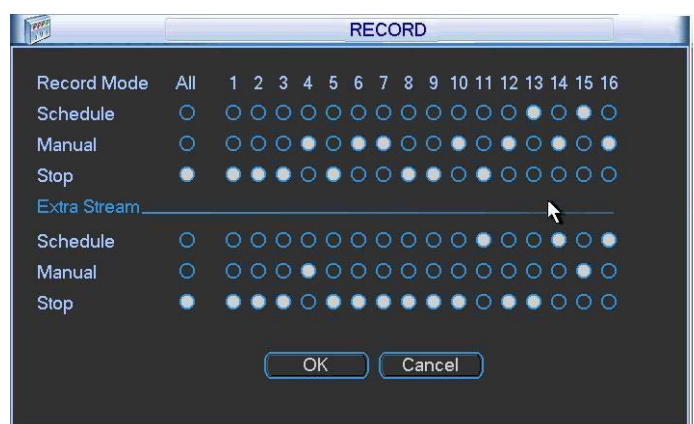

Figure 4-90

4.7.4.4 Enable all channel recording

Highlight ○ below All, you can enable all channel recording.

- All channel schedule record

Please highlight “ALL” after “Schedule”. See Figure 4-91.

When system is in schedule recording, all channels will record as you have previously set (Main menu->Setting->Schedule).

The corresponding indication light in front panel will turn on.

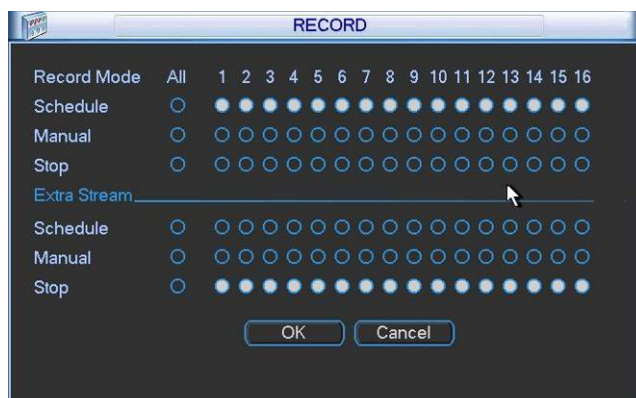

Figure 4-91

- All channel manual record

Please highlight “ALL” after “Manual.” See Figure 4-92.

When system is in manual recording, all scheduled set up you have set in will be null ((Main menu->Setting->Schedule)).

You can see indication light in front panel turns on, system begins manual record now.

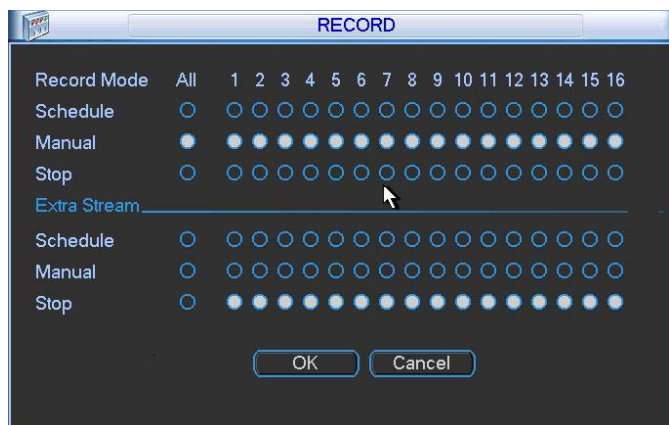

Figure 4-92

4.7.4.5 Stop all channel recording

Please highlight “ALL” after “Stop”. See Figure 4-93.

System stops all channel recording no matter what mode you have set in the menu (Main menu->Setting->Schedule)

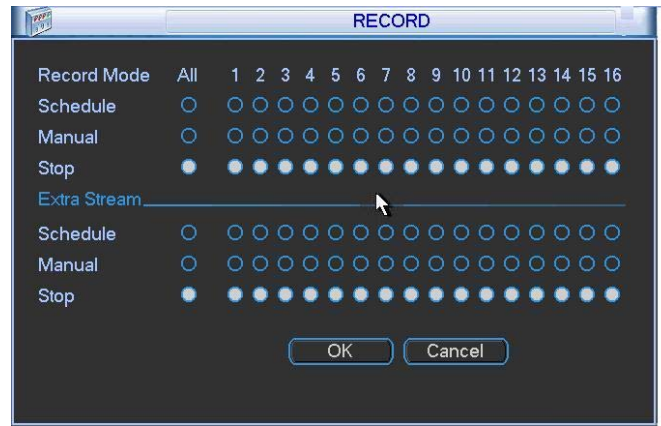

Figure 4-93

4.7.5 Account

Here is for you to implement account management. See Figure 4-94. Here you can:

- Add new user
- Modify user
- Add group
- Modify group
- Modify password.

For account management please note:

- For the user account name and the user group, the string max length is 6-byte. The backspace in front of or at the back of the string is invalid. There can be backspace in the middle. The string includes the valid character, letter, number, underline, subtraction sign, and dot.
- System account adopts two-level management: group and user. No limit to group or user amount.
- For group or user management, there are two levels: admin and user.
- The user name and group name can consist of eight bytes. One name can only be used once. There are four default users: admin/888888/666666 and hidden user “default”. Except user 6666, other users have administrator right.
- Hidden user “default” is for system interior use only and can not be deleted. When there is no login user, hidden user “default” automatically login. You can set some rights such as monitor for this user so that you can view some channel view without login.
- One user should belong to one group. User right can not exceed group right.
- About reusable function: this function allows multiple users use the same account to login.

After all the setups please click save button, system goes back to the previous menu.

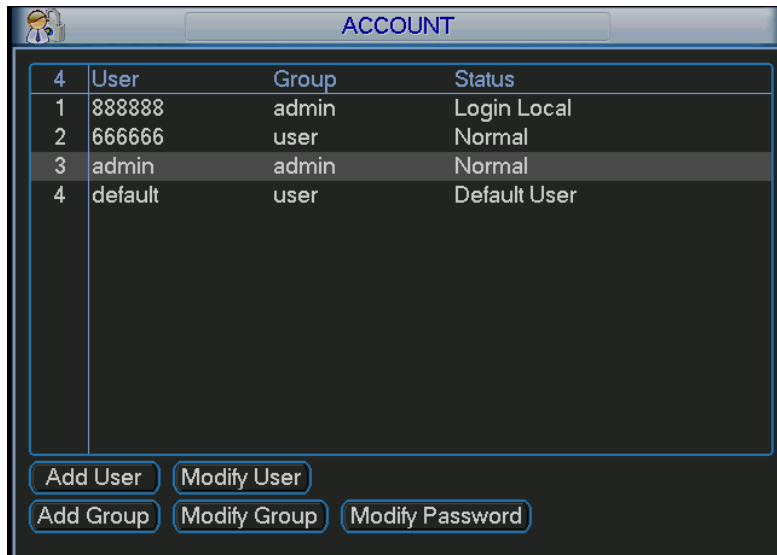

Figure 4-94

4.7.5.1 Modify Password

Click password button, the interface is shown as in Figure 4-95.

Here you can modify account password.

Please select the account from the dropdown list, input the old password and then input the new password twice. Click the Save button to confirm current modification.

For the users of user account right, it can modify password of other users.

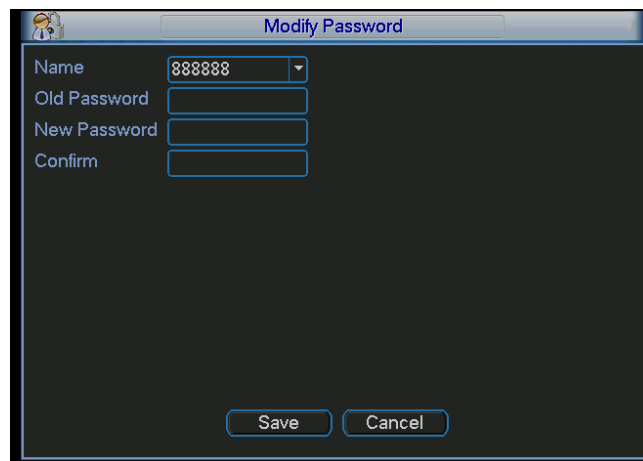

Figure 4-95

4.7.5.2 Add/Modify Group

Click add group button, the interface is shown as below. See Figure 4-96.

Here you can input group name and then input some memo information if necessary.

There are total 60 rights such as control panel, shut down, real-time monitor, playback, record, record file backup, PTZ, user account, system information view, alarm input/output setup, system setup, log view, clear log, upgrade system, control device and etc.

The modify group interface is similar to the Figure 4-96.

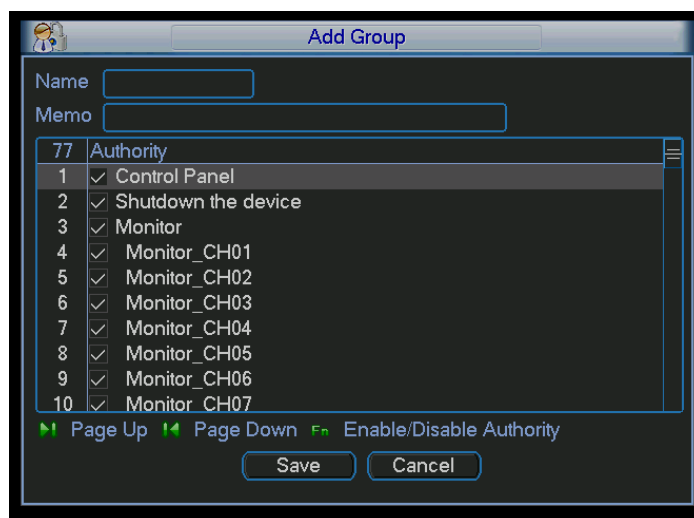

Figure 4-96

4.7.5.3 Add/Modify User

Click add user button, the interface is shown as in Figure 4-97.

Please input the user name, password, select the group it belongs to from the dropdown list.

Then you can check the corresponding rights for current user.

For convenient user management, usually we recommend the general user right is lower than the admin account.

The modify user interface is similar to Figure 4-97.

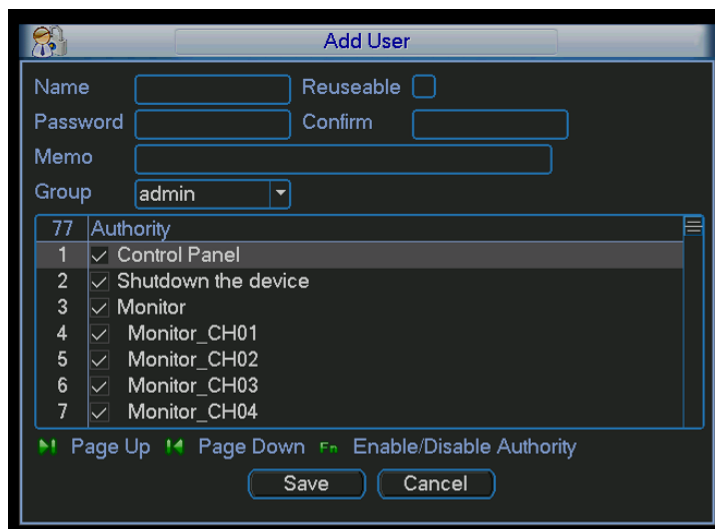

Figure 4-97

4.7.6 Auto Maintenance

Here you can set auto-reboot time and auto-delete old files setup. You can set to delete the files for the specified days. See Figure 4-98.

You can select proper setup from dropdown list.

After all the setups please click save button, system goes back to the previous menu.

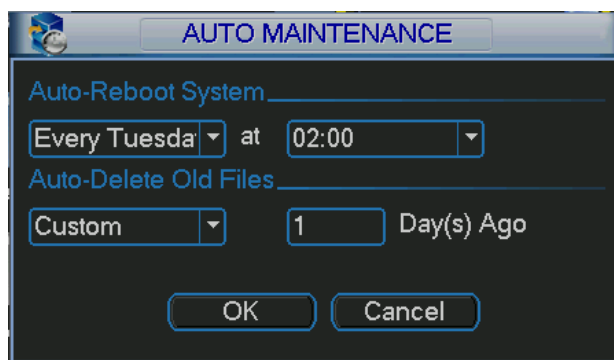

Figure 4-98

4.7.7 Config Backup

The configuration file backup interface is shown as below. See Figure 4-99.

This function allows you to copy current system configuration to other devices. It also supports import, create new folder, delete folder and etc function.

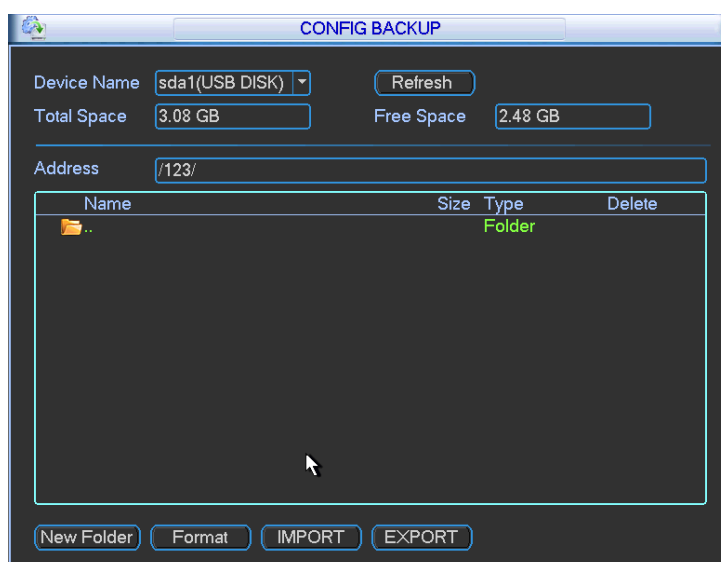

Figure 4-99

4.8 Shutdown

Double click shutdown button, system pops up a dialogue box for you to select. See Figure 4-100.

- Logout menu user: log out menu. You need to input password when you login the next time.
- Restart application: reboot device.
- Shutdown: system shuts down and turns off power.
- Restart system: system begins rebooting.
- Switch user: you can use another account to login.

If you shut down the device, there is a process bar for your reference, system waits for 3 seconds and then shut down (You can not cancel).

Please note, sometimes you need to input the proper password to shut down the device.

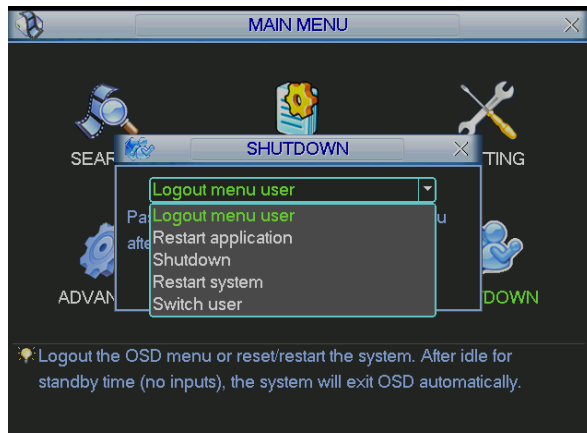

Figure 4-100

Select the “Open Device Web” item; you can go to the corresponding web login interface. See Figure 5-3.

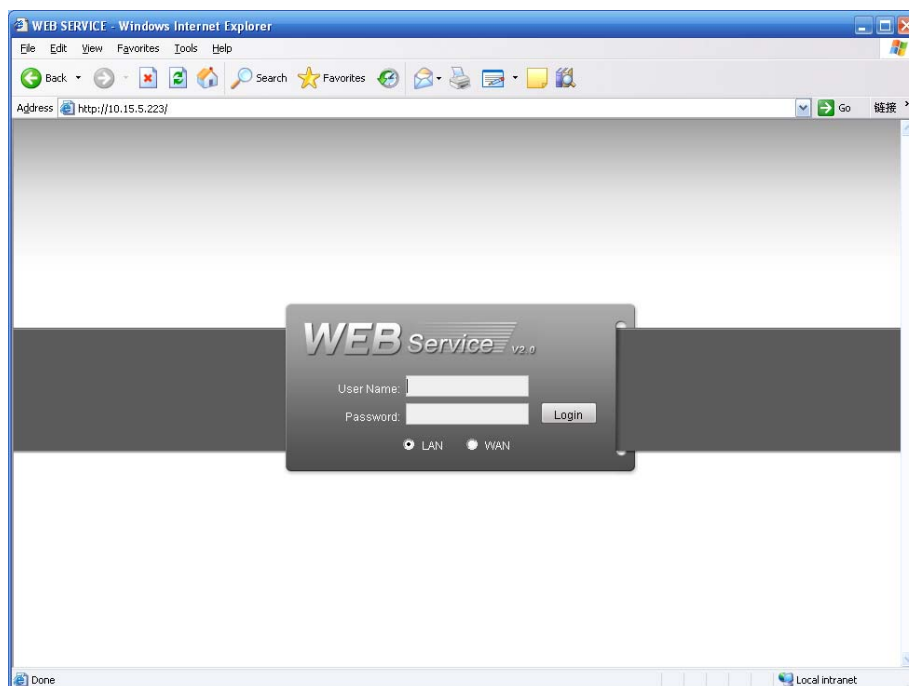

Figure 5-3

If you want to modify the device IP address without logging in the device web interface, you can go to the configuration tool main interface to set.

In the configuration tool search interface (Figure 5-1), please select a device IP address and then double click it to open the login interface. Or you can select an IP address and then click the Login button to go to the login interface. See Figure 5-4.

In Figure 5-4, you can view device IP address, user name, password and port. Please modify the corresponding information to login.

Please note the port information here shall be identical with the port value you set in TCP port in Web Network interface. Otherwise, you can not login the device.

If you are using device background upgrade port 3800 to login, other setups are all invalid.

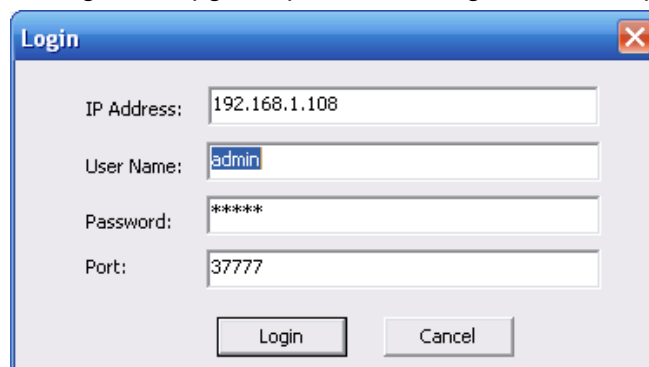

Figure 5-4

After you logged in, the configuration tool main interface is shown as below. See Figure 5-5.

Please refer to the *Quick Configuration Tool User's Manual* included in the resources CD for detail information.

Network Parameter | PPPoE | System Information | System Upgrade

General Parameter

DHCP Enable IPv4

IP Address: 192.168.1.108

Subnet Mask: 255.255.255.0

Gateway: 192.168.1.1

Mac Address: 90:02:a9:00:76:83

Save Return

Figure 5-5

For detailed information and operation instruction of the quick configuration tool, please refer to the *Quick Configuration Tool User's Manual* included in the resources CD.

6 Web Operation

6.1 General Introduction

The device web provides channel monitor menu tree, search, alarm setup, system setup, PTZ control and monitor window.

Important

The following operation is based on 16-channel series device. For the 32-channel series product, there is 32-channel option.

6.1.1 Preparation

Before log in, please make sure:

- Network connection is right
- NVR and PC network setup is right. Please refer to network setup(main menu->setting->network)
- Use order ping `***.***.***.***`(* NVR IP address) to check connection is OK or not. Usually the return TTL value should be less than 255.
- Open the IE and then input NVR IP address.
- System can automatically download latest web control and the new version can overwrite the previous one.
- If you want to un-install the web control, please run `uninstall webrec2.0.bat`. Or you can go to `C:\Program Files\webrec` to remove single folder. Please note, before you un-install, please close all web pages, otherwise the un-installation might result in error.
- Current series product supports various browsers such as Safari, firefox browser, Google browser. Device only support 1-channel monitor on the Apple PC.

About PoE address setup, operation and allocation.

1) Insert PoE

After you insert PoE, device may try to set a corresponding IP address of the Switch network adapter. First, system tries to set via arp ping. It then uses DHCP if it finds the DHCP is enabled. After successfully set IP address, system may use Switch to send out broadcast, system thinks the connection is OK when there is any response. Now system is trying to login the newly found IPC. Now please check the interface, you can see the corresponding digital channel is active now. You can see a small PoE icon at the top left corner. You can see the PoE channel, PoE port information and etc from the connection list of the remote device interface (Chapter 4.6.11). For the IP search list, you need to click the IP search to display or refresh.

2) Remove PoE

After you removed PoE, you can see the corresponding digital channel becomes idle (disable). On the remote device interface, it is removed from the connected list. For the IP search list, you need to click the IP search to refresh.

3) After you insert PoE, system follows the principles listed below to map channel.

- a) If it is your first time to insert PoE, system can map it to the first idle channel. After map, the channel can memorize the MAC address of the IPC. It is a `<Channel>---<IPC mac>` map. If current channel does not connect to other device, system can memorize current MAC address, otherwise it can refresh to the newly added device and memorize the `<PoE port>---<Channel>`.

- b) If it is your second time to insert the PoE, system can check the saved MAC address according to <Channel>---<IPC mac> map to make sure current IPC has connected or not. If system finds the previous information and the channel is idle, system can map it to the previously used channel. Otherwise system goes to the next step.
- c) Thirdly, according to the <PoE port>---<Channel> map, system can know the previous mapping channel of current PoE port. System can select current channel if it is free. Otherwise, it goes to the next step:
- d) Fourthly, system goes to find the first idle channel it can get.

Generally speaking, once you insert PoE, system follow the steps listed above to find the channel available.

4) When you insert PoE, all channels are in use now.

System can pop up a dialogue box for you to select a channel to overwrite. The title of the pop-up interface is the name of the current operation PoE port. In this interface, All PoE channel become grey and can not select.

6.1.2 Log in

Open the IE and then input the NVR IP address in the address column.

For example, if your NVR IP address is 192.168.1.108, then please input http:// 192.168.1.108 in IE address column. See Figure 6-1.

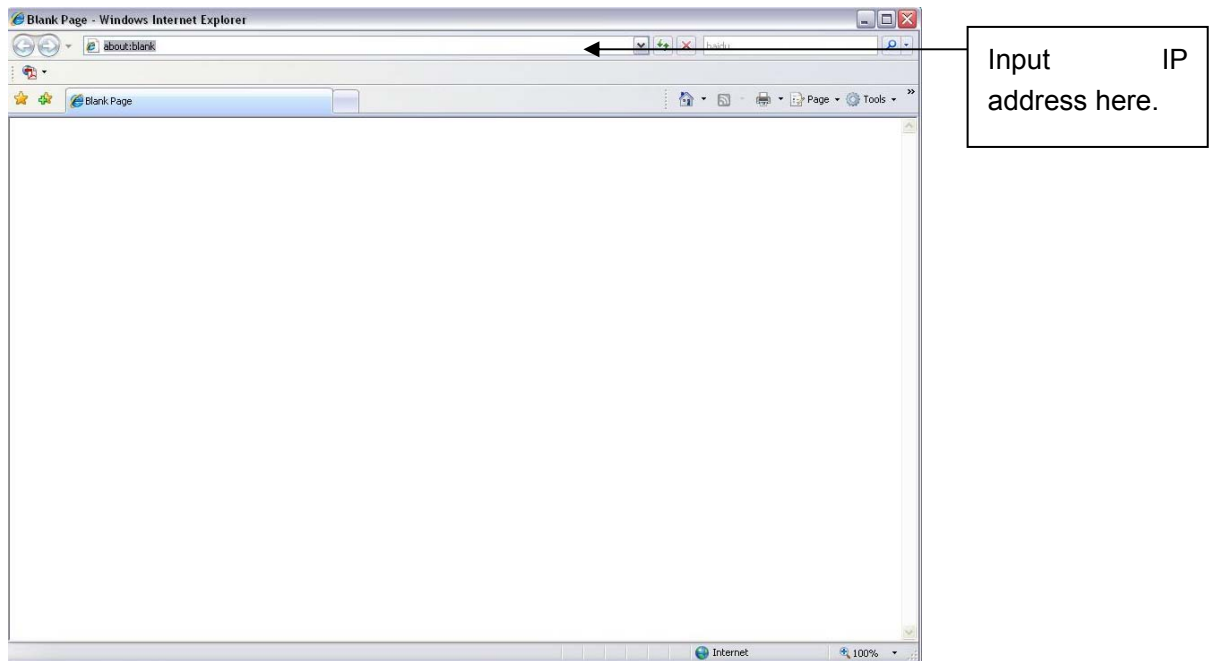

Figure 6-1 IE Interface

System pops up warning information to ask you whether install webrec.cab control or not. Please click yes button.

If you can't download the ActiveX file, please modify your settings as follows. See Figure 6-2.

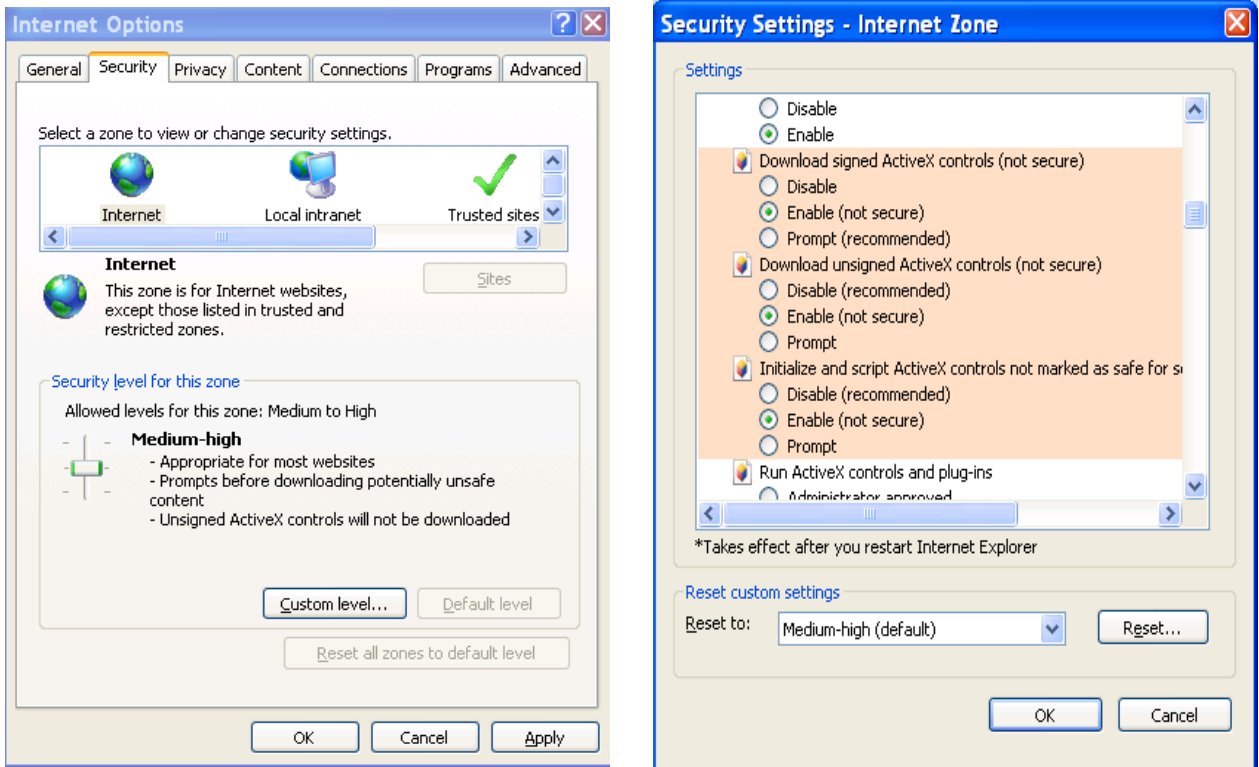

Figure 6-2 IE Safety Setup

After installation, the interface is shown as below. See Figure 6-3.

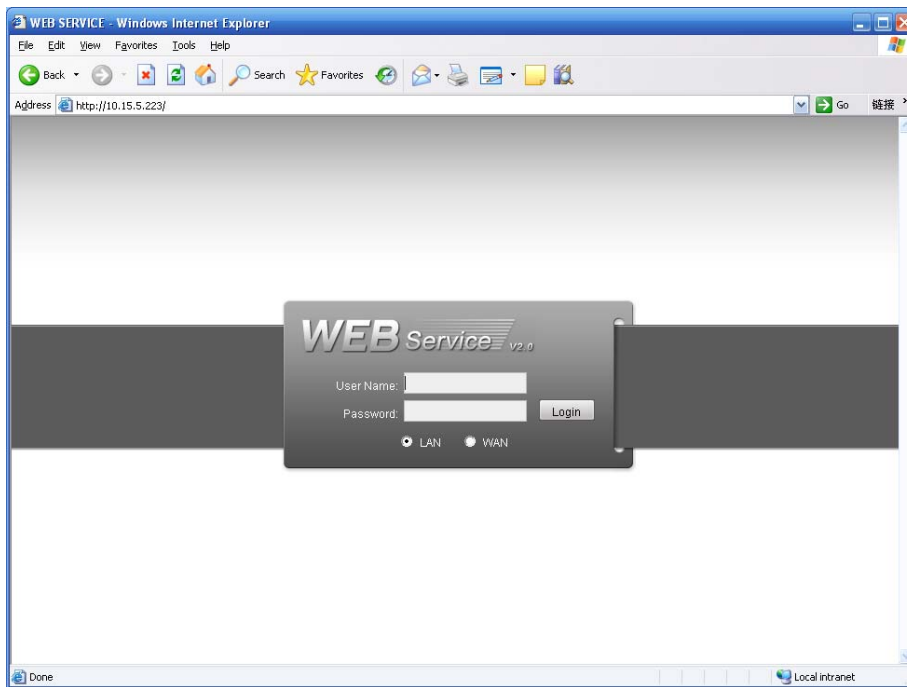

Figure 6-3 Login interface

Please input your user name and password.

Default factory name is **admin** and password is **admin**.

Note: For security reasons, please modify your password after you first login.

6.2 LAN Mode

For the LAN mode, after you logged in, you can see the main window. See Figure 6-4.

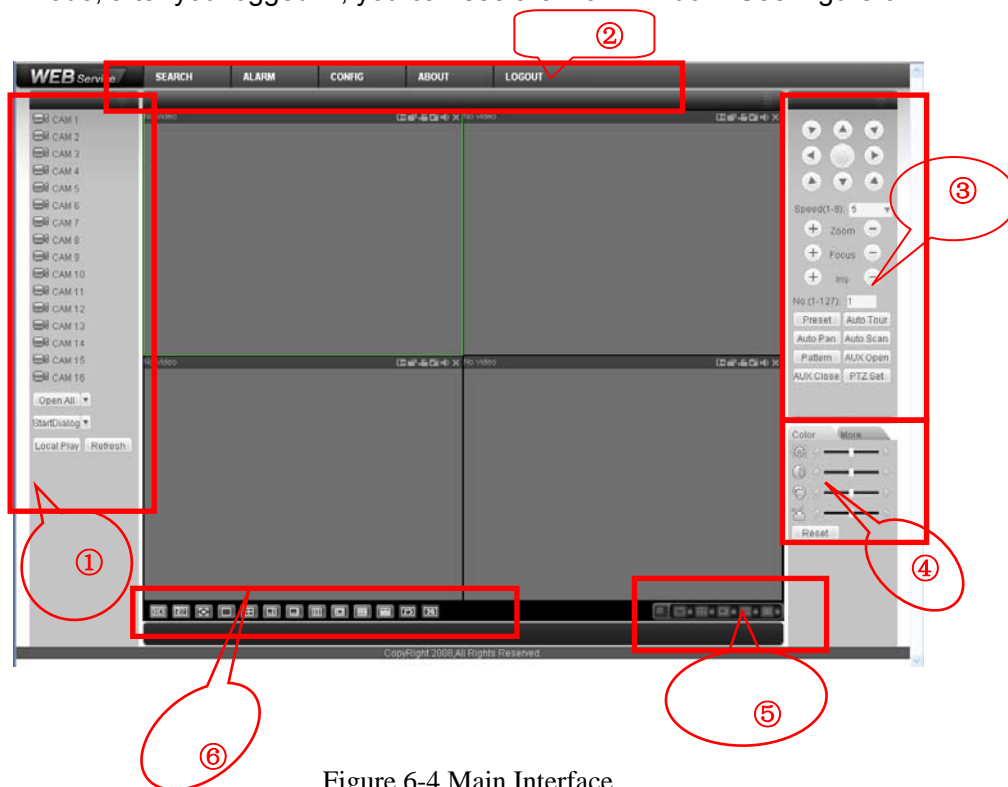

Figure 6-4 Main Interface

There are six sections:

- Section 1: Monitor channel menu tree
- Section 2: System menu
- Section 3: PTZ control
- Section 4: Video setup and other setup
- Section 5: Preview window
- Section 6: Monitor window switch

6.2.1 Monitor Channel Menu Tree

The monitor channel menu tree is shown as in Figure 6-5.

Please note the following figure is for reference only. For 32-channel series product, there are 32 channels.

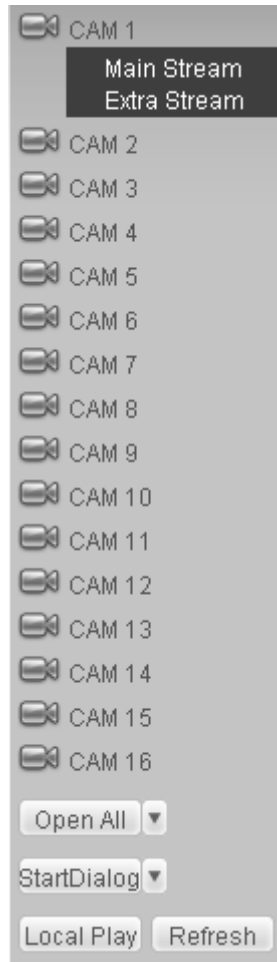



Figure 6-5 Monitor Channel Menu Tree

Please refer to the following sheet for detailed information.

Parameter	Function
CAM 1 to CAM 16	channel 1 to channel 16
Open all /close all	Click this button to open all video channels. Once all video channels are open, it becomes close all button.
Start Dialogue	You can click this button to enable audio talk. Click 【▼】 to select bidirectional talk mode. There are four options: DEFAULT, G711a, G711u and PCM. Please note, the audio input port from the device to the client-end is using the first channel audio input port. During the bidirectional talk process, system will not encode the audio data from the 1-channel.

<p>Local play</p>	<p>The Web can playback the saved (Extension name is dav) files in the PC-end.</p> <p>Click local play button, system pops up the following interface for you to select local play file. See Figure 6-6.</p>  <p style="text-align: center;">Figure 6-6</p>
<p>Refresh</p>	<p>Click this button to refresh monitor channel name.</p>

Please left click one monitor to view real-time video, the monitor window is shown as in Figure 6-7.

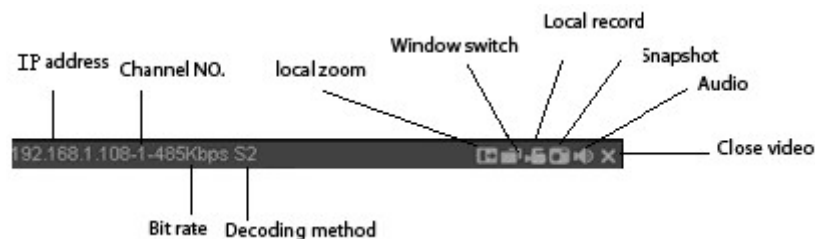

Figure 6-7 Real-time Monitor

Please refer to the following sheet for monitor window parameter information.

Parameter	Function
<p>Display device information</p>	<ul style="list-style-type: none"> ● 1: NVR IP address. ● 2: Channel number. ● 3: Bit stream. ● 4: Bit stream decode type. <ul style="list-style-type: none"> ➢ S1: Overlay. ➢ S2: Off stream. ➢ S3:GD1 ➢ H1: Overlay ➢ H2: off stream decoding from the display card.
<p>Digital zoom</p>	<p>Click this button and then left drag the mouse in the zone to zoom in. Right click mouse system restores original status.</p>

Change show mode	Resize or switch to full screen mode.
Local record	When you click local record button, the system begins recording. The recorded file is saved to system folder: \ RecordDownload(default).
Snapshot	You can snapshot important video. All images are memorized in system folder: \ picture download (default).
Audio	Turn on or off audio.
Close video	Close video in current window.

6.2.2 System Menu

System menu is shown as in Figure 6-8.

Please refer to chapter 6.4 Configuration, chapter 6.5 Search, chapter 6.6 Alarm, chapter 6.7 About, chapter 6.8 Log out for detailed information.



Figure 6-8 System Menu

6.2.3 Monitor Window Switch

The monitor window switch interface is shown as in Figure 6-9.



Figure 6-9 Monitor Window Switch

System supports 1/4/6/8/9/13/16/20/25/36-window real-time preview.



----It is video quality adjustment button. It has relationship with decode via software.



--Fluency button. You can use this function to adjust the priority between real-time and fluency.

6.2.4 PTZ Control

Before PTZ operation, please make sure you have properly set PTZ protocol. (Please refer to chapter 6.4.2.2 PTZ).

Here you can view direction keys, speed, zoom, focus, iris, preset, tour, pan, scan, pattern, aux close, and PTZ setup button.

Please note: open menu/close menu/up/down/left/right/confirm/cancel buttons are for speed dome only.

- PTZ direction: PTZ supports eight directions: left/right/up/down/upper left/upper right/bottom left/bottom right.
- Speed: The step 8 speed is faster than step 1.

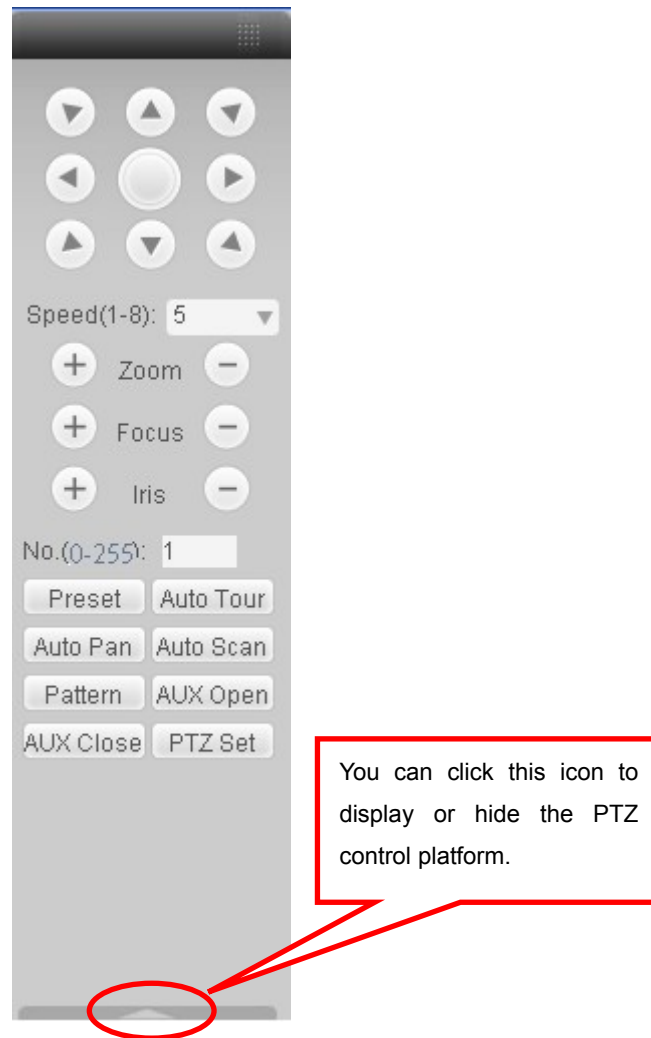

Figure 6-10 PTZ Interface

Click PTZ set button, the interface is shown as in Figure 6-11.

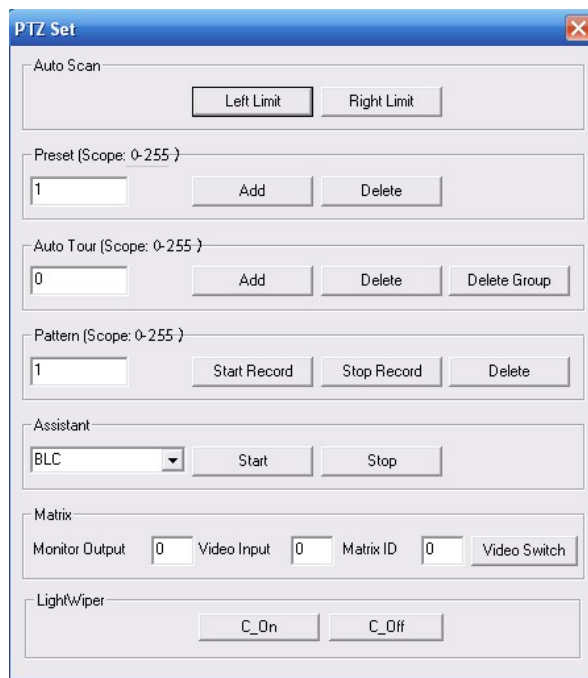

Figure 6-11 PTZ Setup

Please refer to the following sheet for PTZ setup information.

Parameter	Function
Scan	<ul style="list-style-type: none"> ● Move the camera to you desired location and then click left limit button. ● Then move the camera again and then click right limit button to set a right limit.
Preset	Use direction keys to move the camera to your desired location and then input preset value. Click add button, you have set one preset.
Tour	<ul style="list-style-type: none"> ● Input auto tour value and preset value. Click add button, you have added one preset in the tour. ● Repeat the above procedures you can add more presets in one tour. ● Or you can click delete button to remove one preset from the tour.
Pattern	You can input pattern value and then click start record button to begin PTZ movement. Please go back to Figure 7-10 to implement camera operation. Then you can click stop record button in Figure 7-11. Now you have set one pattern.
Assistant	<p>The assistant items include: BLC, Digital zoom, night vision, camera brightness, flip.</p> <p>You can select one option and then click start or stop button.</p>
Matrix	Please select matrix x and then input corresponding monitor output channel number, video input channel number. Then you can click video switch button.
Light/wiper	You can control the light and wiper of the peripheral device. Please note the peripheral device shall support this function.

6.2.5 Color and More Setup

Color and other setup interface are shown as in Figure 6-12.

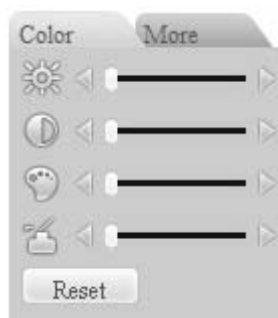





Figure 6-12 Color

Please refer to the following sheet for detailed information.

Parameter	Function	Note:
Video setup 	It is to adjust monitor video brightness.	

	It is to adjust monitor video contrast ness.	All the operation here applies to WEB end only.
	It is to adjust monitor video saturation.	
	It is to adjust monitor video hue.	
Reset	Restore system default value.	

Click more button, the interface is shown as in Figure 6-13.

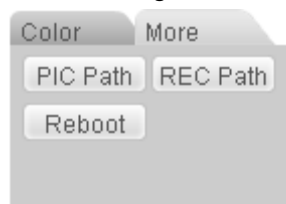

Figure 6-13 Color and More

Please refer to the following sheet for detailed information.

Parameter		Function
More	Picture Path	Click picture path button, system pops up an interface for you to modify path.
	Record Path	Click record path button, system pops up an interface for you to modify path.
	Reboot	Click this button to reboot device. If there is local use logged in the system menu, or the Web logged in user has no right to reboot the device system pops up a dialogue box to alert you.

6.3 WAN Login

In WAN mode, after you logged in, the interface is shown as below. See Figure 6-14.

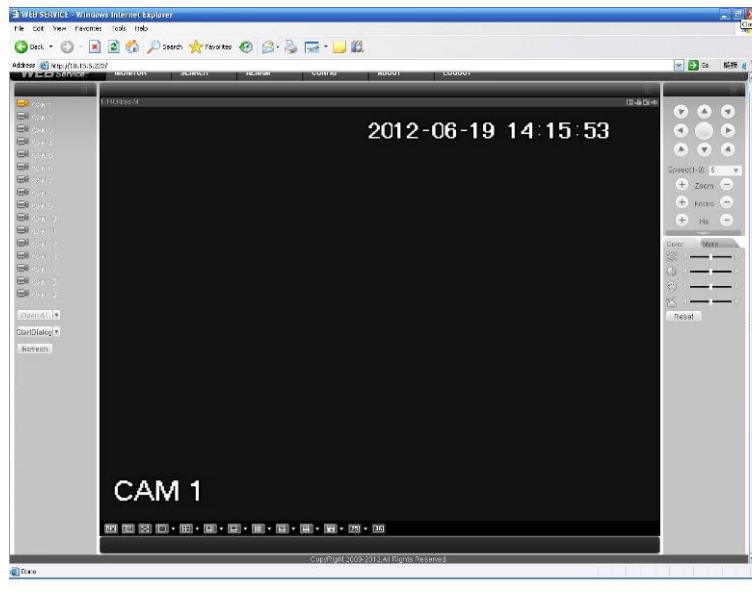

Figure 6-14

Please refer to the following contents for LAN and WAN login difference.

- 1) In the WAN mode, system opens the main stream of the first channel to monitor by default. The open/close button on the left pane is null.
- 2) You can select different channel and different monitor mode at the bottom of the interface. See Figure 6-15.

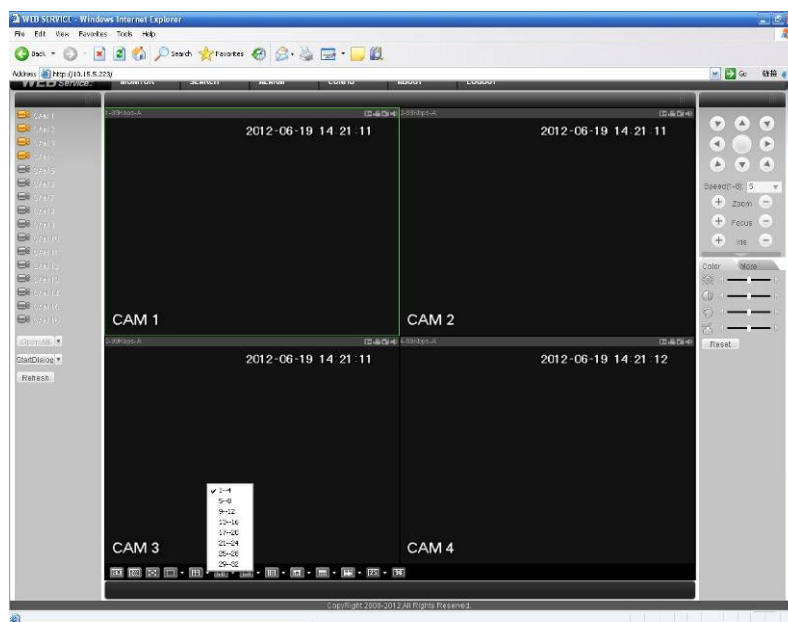

Figure 6-15

Important

The window display mode and the channel number are by default. For example, for the 16-channel, the max window split mode is 16.

- 3) Multiple-channel monitor, system adopts extra stream to monitor by default. Double click one channel, system switches to single channel and system uses main stream to monitor. You can view there are two icon at the left top corner of the channel number for you reference. M stands for

main stream. A stands for

4) When you switch from Monitor to Search or Configuration, system pops a dialogue box asking you leave current interface or not. See Figure 6-16. Click the OK button, system will close current monitor window. For example, you click the Config button when you are monitoring, system pops up a following dialogue. Click the OK button, system closes current monitor interface and open the configuration interface. The monitor interface appears automatically after you close configuration interface. When you switch from Search to the Configuration interface, system also pops up the same dialogue box for your confirmation. Click OK button, you can see system close playback interface and open the configuration interface. Please note, system will not open the playback interface again after you close the configuration interface.



Figure 6-16

5) If you login via the WAN mode, system does not support alarm activation to open the video function in the Alarm setup interface.

Important

- For multiple-channel monitor mode, system adopts extra stream to monitor by default. You can not modify manually. All channels are trying to synchronize. Please note the synchronization effect still depends on your network environments.
- For bandwidth consideration, system can not support monitor and playback at the same time. System auto closes monitor or playback interface when you are searching setup in the configuration interface. It is to enhance search speed.

6.4 Configuration

6.4.1 System Information

6.4.1.1 Version Information

Here you can view device hardware feature and software version information. See Figure 6-17.

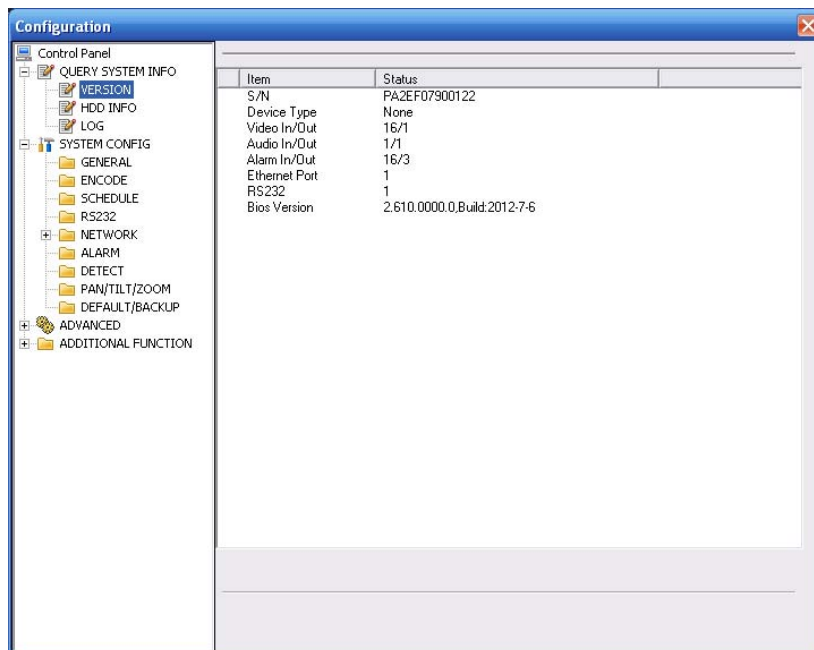

Figure 6-17 Version Information

6.4.1.2 HDD information

Here you can view local storage status such as free capacity and total capacity. See Figure 6-18.

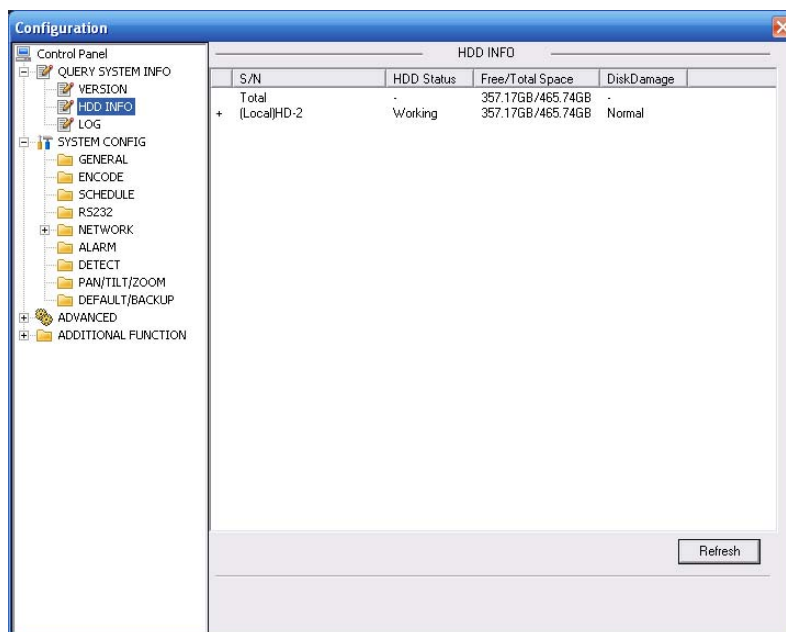

Figure 6-18 HDD Information

6.4.1.3 Log

Here you can view system log. See Figure 6-19

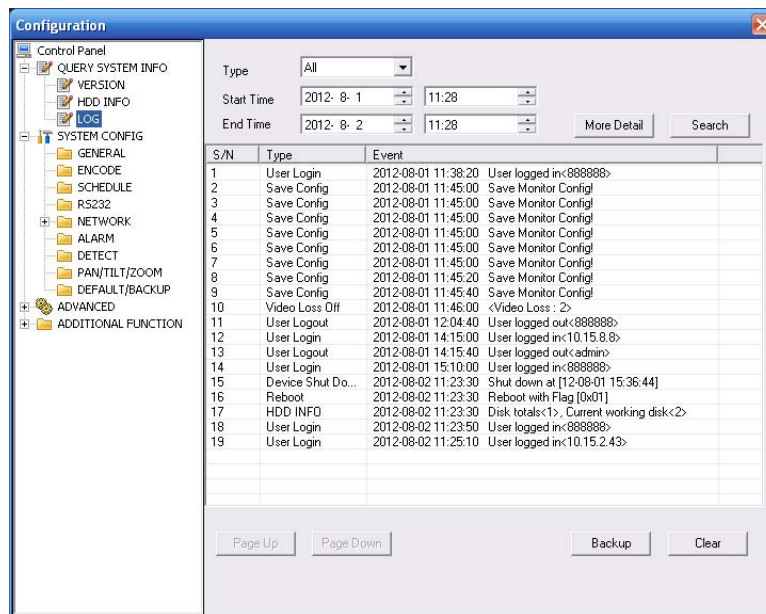

Figure 6-19 Log

Please refer to the following sheet for log parameter information.

Parameter	Function
Type	Log types include: system operation, configuration operation, data management, alarm event, record operation, user management, log clear and file operation.
Start time	Set time to start search.
Finish time	Set time to finish search
Search	You can select log type from the drop down list and then click search button to view the list.
Clear	You can click this button to delete all displayed log files. Please note system does not support clear by type.
Backup	You can click this button to backup log files to current PC.

6.4.2 System Configuration

Please click save button to save your current setup. Please click refresh button to view the latest setup.

6.4.2.1 General Setup

Here you can set system time, record length, video format and etc. See Figure 6-20.

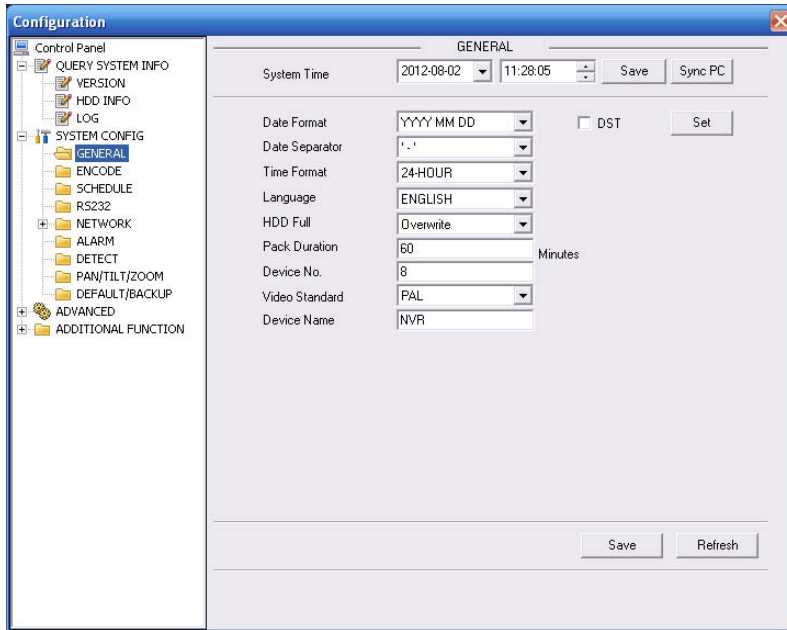

Figure 6-20 General Setup

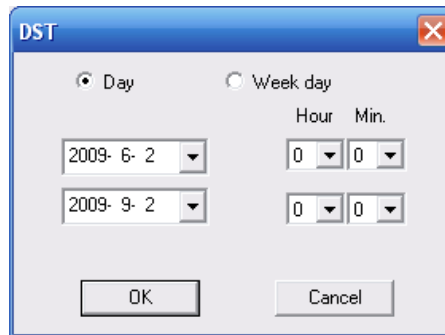

Figure 6-21 DST

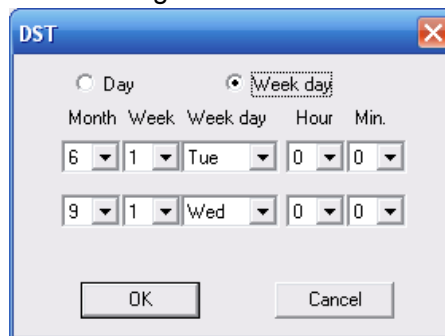

Figure 6-22 DST

Please refer to the following sheet for detailed information.

Parameter	Function
System Time	Here is for you to modify system time. Please click Save button after your completed modification
Sync PC	You can click this button to save the system time as your PC current time.
Data Format	Here you can select data format from the dropdown list.

Data Separator	Please select separator such as – or /.
Time Format	There are two options: 24-H and 12-H.
DST	Here you can set day night save time begin time and end time. See Figure 6-21and Figure 6-22.
Language	Here you can view the system current language. You can select from the dropdown list.
HDD Full	There are two options: stop recording or overwrite the previous files when HDD is full.
Pack Duration	Here you can select file size. The value ranges from 1 to 120 (minute). Default setup is 60 minutes.
Device No	When you are using one remote control to manage multiple devices, you can give a serial numbers to the device. Please note current series product does not support this function.
Video Standard	Here you can view video format such as PAL.

6.4.2.2 Encode

The encode interface is shown as in Figure 6-23.

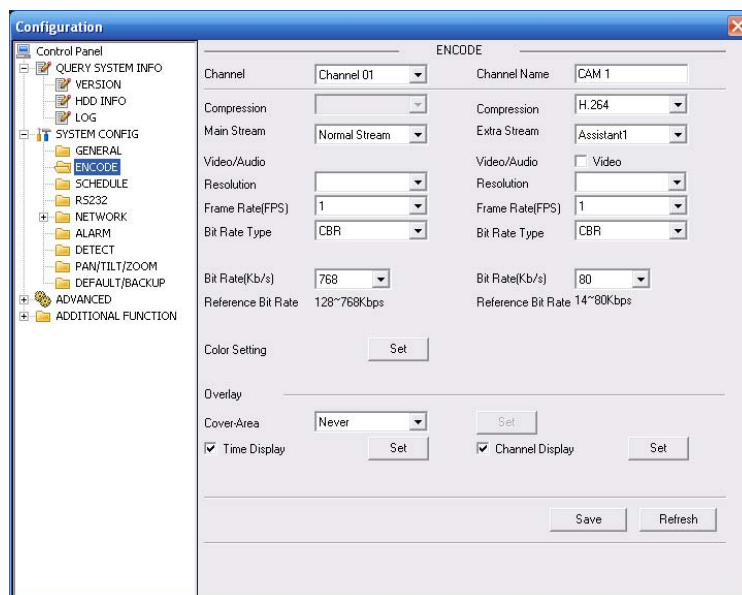

Figure 6-23 Encode

Please refer to the following sheet for detailed information.

Parameter	Function
Channel	Select the corresponding channel.
Channel Name	Display the current channel ID. You can also modify the channel ID here.
Encoding mode	The device does not support it.

Audio / video	For the main stream, recorded file only contains video by default. You need to draw a circle here to enable audio function. For extra stream, you need to draw a circle to select the video first and then select the audio if necessary.
Resolution	Main code stream types are D1/HD1/2CIF/CIF/QCIF Channel 1~16 extra code stream supports CIF/QCIF.
Frame rate	PAL: 1f/s-25f/s; NTSC: 1f/s-30f/s
Bit rate	There are two options: VBR and CBR. Please note, you can set video quality in VBR mode only.
Reference bit	The bigger bit value, the better the image quality. Reference bit is an ideal range for you to set bit rate.
Overlay (Cover area)	Here you can privacy mask the specified video in the monitor video. One channel max supports 4 privacy mask zones. The privacy mask includes two options: Never/monitor. Never: It means do not enable privacy mask function. Monitor: the privacy mask zone can not be viewed in monitor mode.
Time display	You can enable this function so that system overlays time information in video window.
Channel display	You can enable this function so that system overlays channel information in video window.

6.4.2.3 Schedule

Here you can set different periods for various days. There are max six periods in one day. See Figure 6-24.

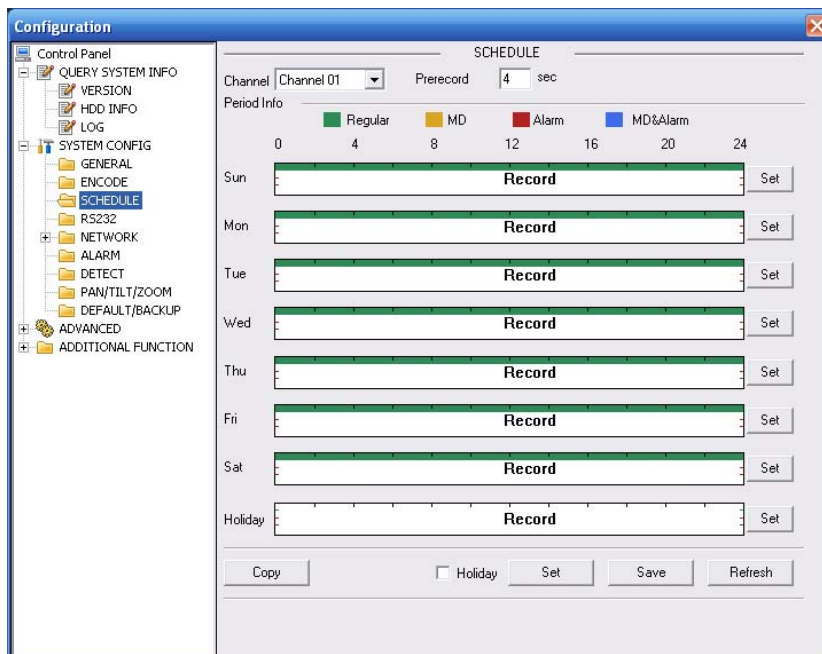

Figure 6-24 Schedule



Figure 6-25 Schedule Time

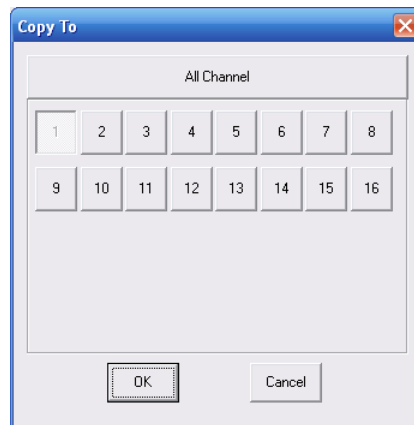

Figure 6-26 Copy

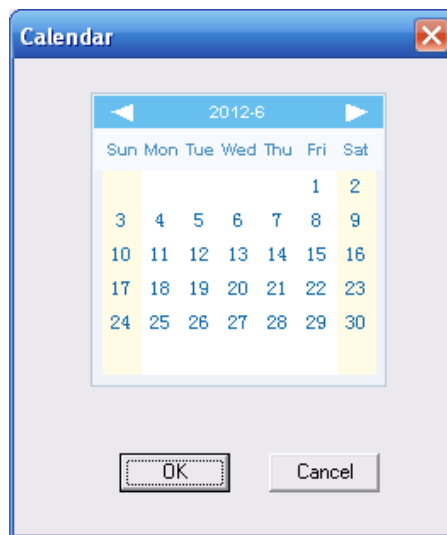

Figure 6-27

Please refer to the following sheet for detailed information.

Parameter	Function
Channel	Please select a channel first.

Parameter	Function
Pre-record	Please input pre-record value here. When alarm record or motion detection record occurs, system can record the several seconds video before activating the record operation into the file. (Depends on data size).
Setup	In Figure 6-24, click set button, you can go to the corresponding setup interface. See Figure 6-25. Please set schedule period and then select corresponding record type: schedule, motion detection, and alarm. Please select date (Current setup applies to current day by default. You can draw a circle before the week to apply the setup to the whole week.) After complete setup, please go back to Figure 6-24 and then click save to save current time period setup.
Holiday	Click Set button, system pops up a dialogue box shown as in Figure 6-27. Here you can set holiday date. Check the box, it means current channel shall record as your holiday setup. Please go to the Period interface set the holiday date record setup.
Copy	It is a shortcut menu button. You can copy current channel setup to one or more (all) channels. The interface is shown as in Figure 6-26.

6.4.2.4 RS232

The RS232 interface is shown as in Figure 6-28.

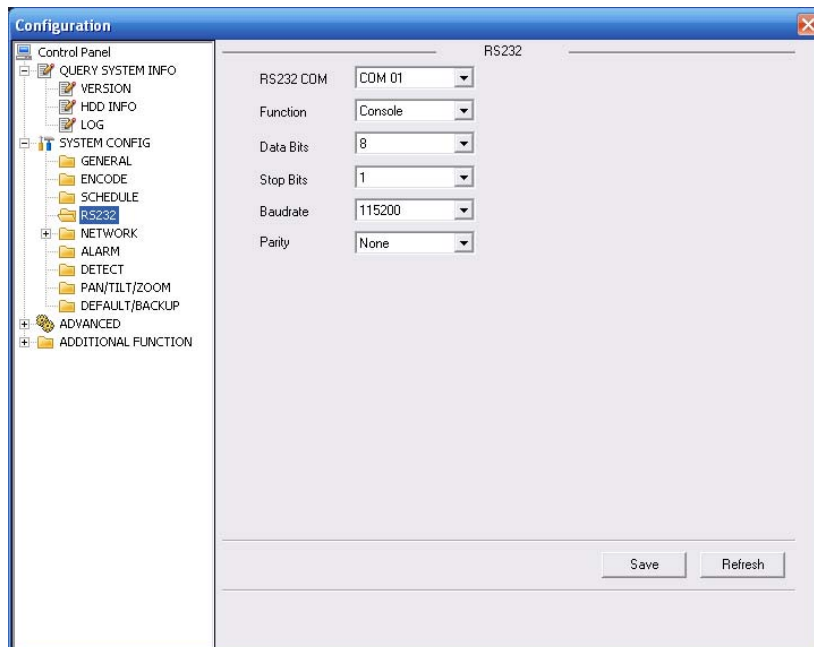

Figure 6-28 RS232

Please refer to the following sheet for detailed information.

Parameter	Function
RS232	There is only one option COM 01, corresponding to RS232.
Function	<p>Console is for debug.</p> <p>Control keyboard: Switch between RS232 and control keyboard.</p> <p>Network keyboard: COM control protocol. You can use network keyboard to control NVR via COM.</p> <p>Transparent COM: Network user can communicate with RS232 COM device.</p> <p>PTZ matrix: PTZ matrix protocol. You can use the device to control the PTZ matrix.</p>
Data Bit	The value ranges from 5 to 8.
Stop Bit	There are three options: 1/2.
Baud Bit	You can select corresponding baud bit here.
Parity	There are five options: none/odd /even/mark/space.

6.4.2.5 Network

Network interface is shown as in Figure 6-29.

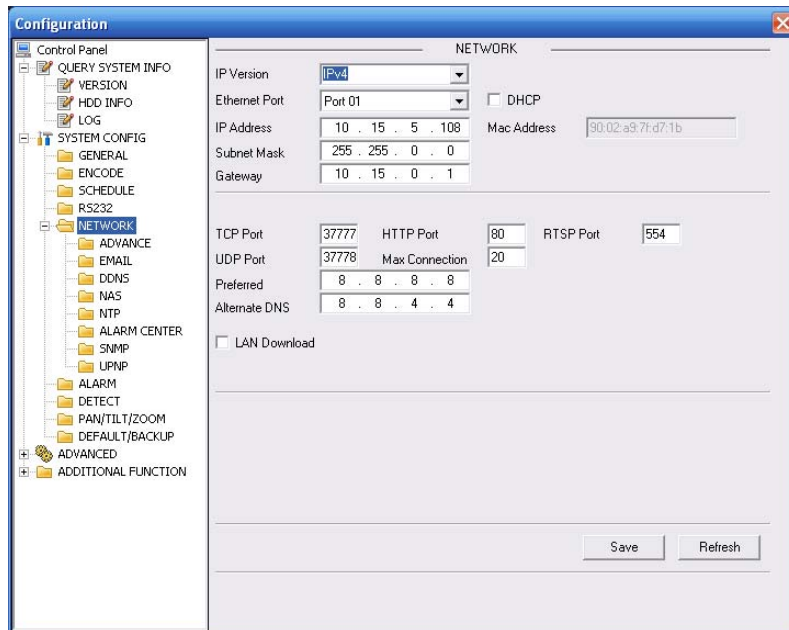

Figure 6-29 Network

Please refer to the following sheet for detailed information.

Parameter	Function
IP Version	There are two options: IPv4 and IPv6. Right now, system supports these two IP address format and you can access them.

Parameter	Function
MAC Address	The host in the LAN can get a unique MAC address. It is for you to access in the LAN. It is read-only.
IP Address	Here you can use up/down button (▲▼) or input the corresponding number to input IP address. Then you can set the corresponding subnet mask the default gateway.
Subnet Prefix	The input value ranges from 0 to 128. It is to mark a specific network MAC address. Usually it includes an organization multiple-level.
Default Gateway	Here you can input the default gateway.
TCP Port	Default value is 37777. You can change if necessary.
HTTP Port	Default value is 80.
RTSP port	Default value is 554.
UDP Port	Default value is 37778. You can change if necessary.
Max Connection	Network user max amount. The value ranges from 0 to 20. 0 means there is no user can access current device.

Please note system needs to check the validity of all IPv6 addresses. The IP address and the default gateway shall be in the same IP section. That is to say, the specified length of the subnet prefix shall have the same string.

For the IP address of IPv6 version, default gateway, preferred DNS and alternate DNS, the input value shall be 128-digit. It shall not be left in blank.

Advanced setup

The remote host can choose multi-cast and PPOE to set. See Figure 6-30.

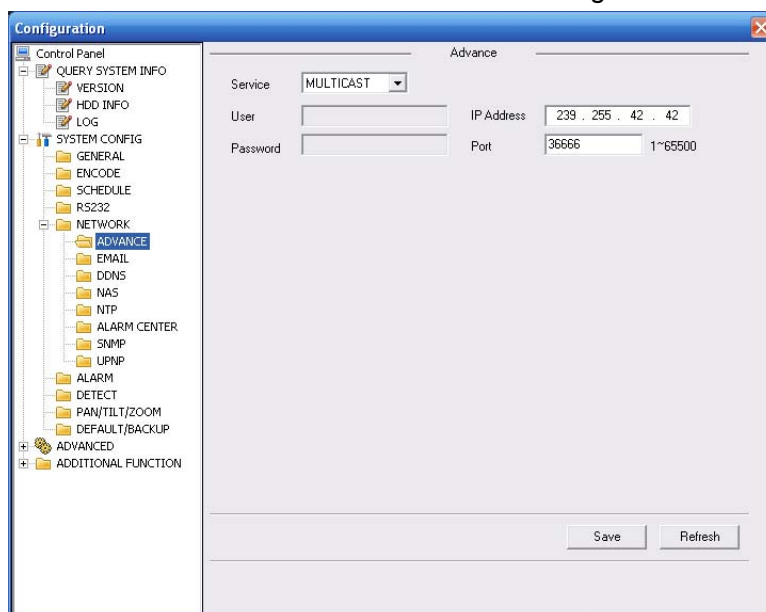

Figure 6-30 Network

Parameter		Function
Remote host	PPPOE	<ul style="list-style-type: none"> ✧ Input the user name and password which ISP(Internet service supplier) provided and chose enable. ✧ Reboot system after configuration is saved and the device will auto connect to Internet. The IP address is the WAN IP. <ul style="list-style-type: none"> ✧ There are two conditions for reboot, <ol style="list-style-type: none"> 1. The user must have the authority to reboot device. 2. There is no user login the system menu on the local end ✧ After PPPOE dial succeed, get the current IP address and visit this IP address via WEB.

Email

The email interface is shown as in Figure 6-31.

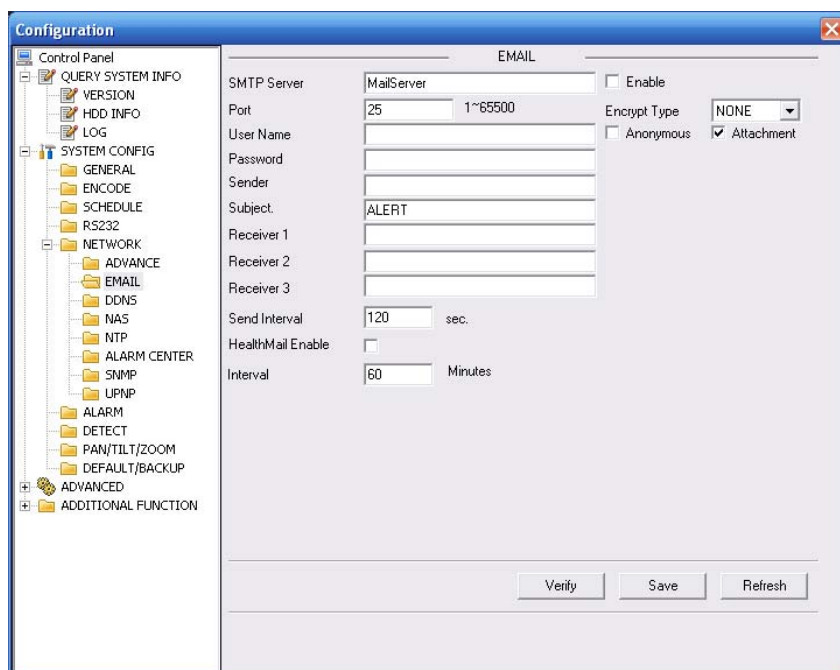

Figure 6-31 Email

Please refer to the following sheet for detailed information.

Parameter	Function
SMTP Server	Input server address and then enable this function. You can also input the corresponding server domain name here, but you need to go to DNS interface (chapter 7.3.4.1) to set the server IP that can parse the domain.
SSL enable	You can enable SSL encryption function to guarantee data safety.
Port	Default value is 25. You can modify it if necessary.
User Name	The sender email account user name.
Password	The sender email account password.
Sender	Sender email address.

Parameter	Function
Subject	Input email subject here. Max 32-digit.
Address	Input receiver email address here. Max input three addresses.
Interval	Please input the send interval value here.

DDNS

The DDNS interface is shown as in Figure 6-32.

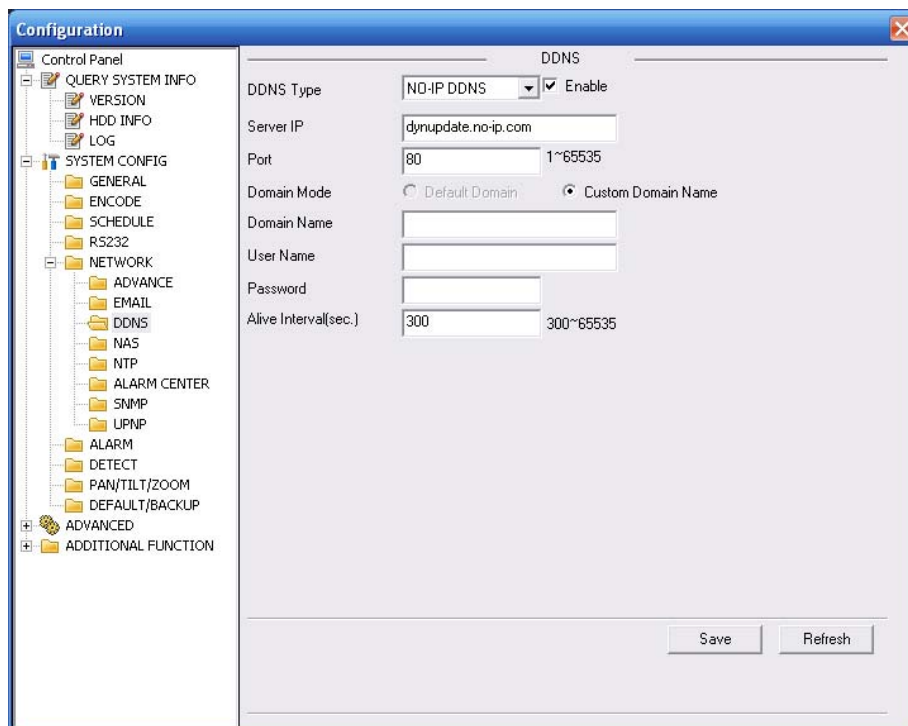

Figure 6-32 DDNS

Please refer to the following sheet for detailed information.

Parameter	Function
Server Type	You can select DDNS protocol from the dropdown list and then enable DDNS function.
Server IP	DDNS server IP address
Server Port	DDNS server port.
Domain Name	Your self-defined domain name.
User	The user name you input to log in the server.
Password	The password you input to log in the server.
Interval	Device sends out alive signal to the server regularly. You can set interval value between the device and DDNS server here.

Private DDNS and Client-end Introduction

1) Background Introduction

Device IP is not fixed if you use ADSL to login the network. The DDNS function allows you to access the NVR via the registered domain name. Besides the general DDNS ,the private DDNS

works with the device from the manufacturer so that it can add the extension function.

2) Function Introduction

The private DDNS client has the same function as other DDNS client end. It realizes the bonding of the domain name and the IP address. Right now, current DDNS server is for our own devices only. You need to refresh the bonding relationship of the domain and the IP regularly. There is no user name, password or the ID registration on the server. At the same time, each device has a default domain name (Generated by MAC address) for your option. You can also use customized valid domain name (has not registered.).

3) Operation

Before you use our private DDNS, you need to enable this service and set proper server address, port value and domain name.

- Server address: www.quickddns.com
- Port number: 80
- Domain name: There are two modes: Default domain name and customized domain name. Except default domain name registration, you can also use customized domain name (You can input your self-defined domain name.) After successful registration, you can use domain name to login installed of the device IP.
- User name: It is optional. You can input your commonly used email address.

Important

- Do not register frequently. The interval between two registrations shall be more than 60 seconds. Too many registration requests may result in server attack.
- System may take back the domain name that is idle for one year. You can get a notification email before the cancel operation if your email address setup is OK.

NAS

NAS interface is shown as in Figure 6-33.

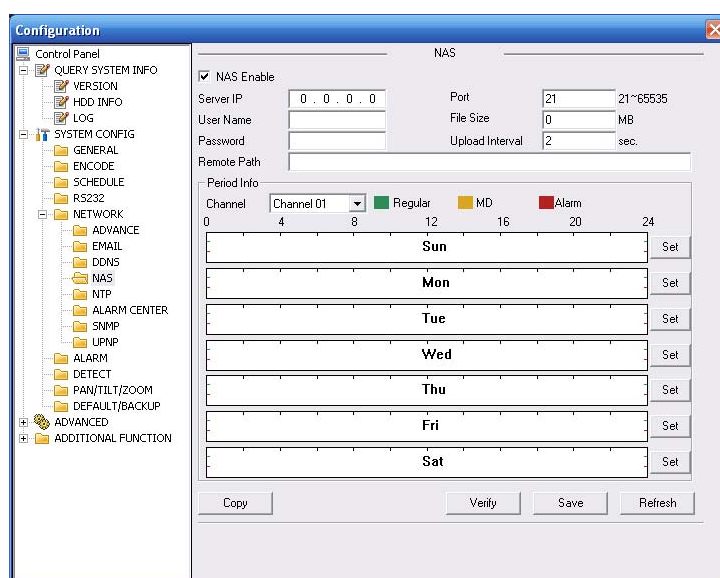

Figure 6-33 NAS

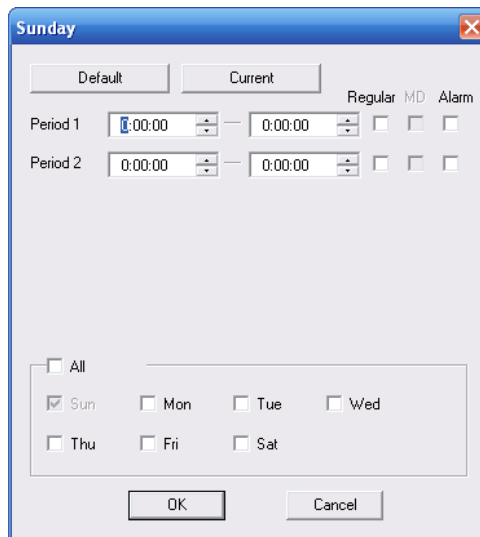

Figure 6-34 NAS Setup

Please refer to the following sheet for detailed information.

Parameter		Function
NAS enable		Please select network storage protocol and then enable NAS function. The network storage protocol includes FTP.
Server IP		Input remote storage server IP address.
Port		Input Remote storage server port number.
User Name		Log in user account.
File length		The max files length when you transfer the file. When the input value is 0, then system upload the whole files.
Password		The password you need to login the server.
Remote Path		Remote storage file path.
Period info.	Channel	Select a monitor channel .
	Setup	<ul style="list-style-type: none"> In NAS interface, click set button, you can go to the corresponding setup interface. See Figure 6-34. .Please set schedule period and then select corresponding record type: schedule/alarm. Please note device does not support motion detect record function now. Please select date (Current setup applies to current day by default. You can draw a circle before the week to apply the setup to the whole week.) After complete setup, please go back to Figure 7-28 and then click save to save current time period setup.
Copy		User can use this shortcut to copy the storage state of a channel to another (or all other channels)

NTP

The NTP interface is shown as in Figure 6-35.

Here you can realize network time synchronization. Please enable current function and then input server IP, port number, time zone and time.

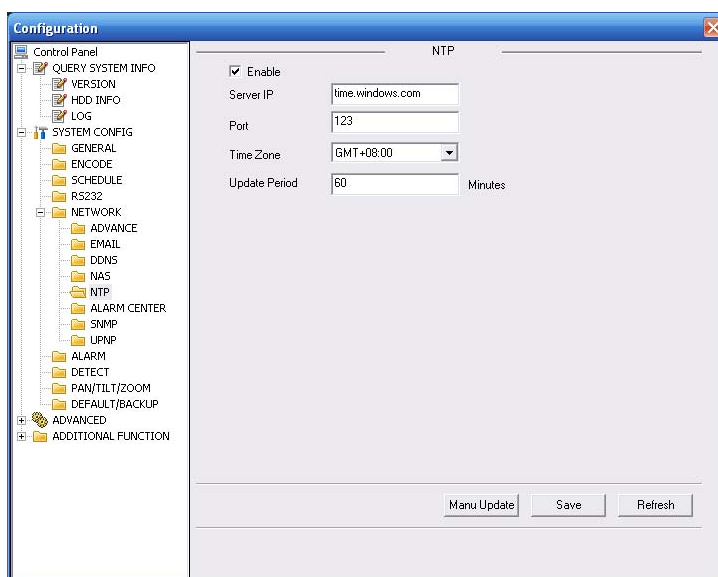

Figure 6-35 NTP

Please refer to the following sheet for detailed information.

Parameter	Function
Enable	Enable NTP function or not.
Server IP	Server IP address
Port	Server port. System supports TCP only and default port value is 123.
Time Zone	Device current time zone.
Update Interval	Time update interval value.

Alarm Centre

Alarm centre interface is shown as below. See Figure 6-36.

Please input alarm centre server IP, port number. Once there is an alarm occurred, system can notify the alarm centre as you specified here.

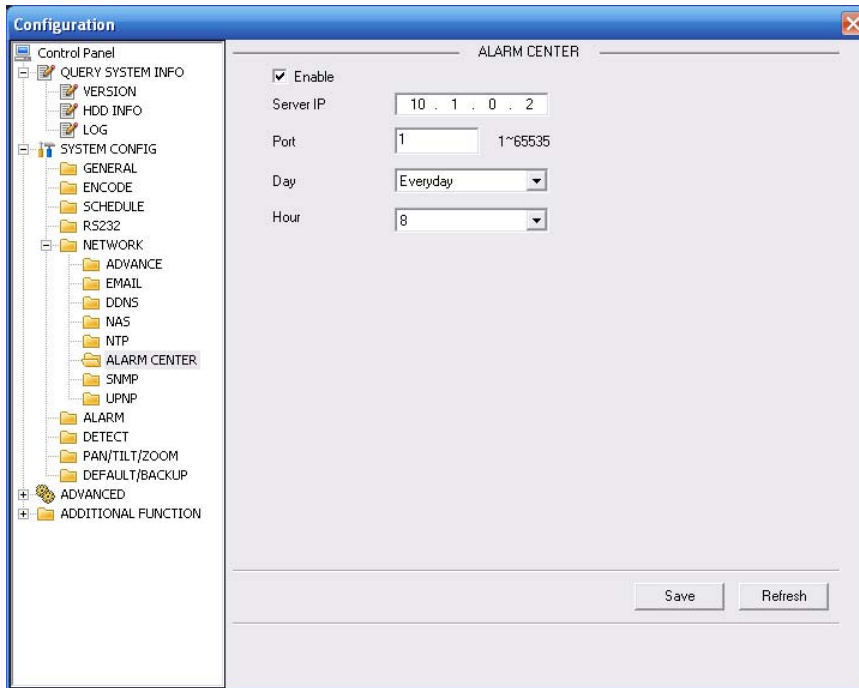

Figure 6-36 Alarm Centre

UNPN

Go to the UPnP interface, you can see an image is shown as in Figure 6-37.

It allows you to establish the mapping relationship between the LAN and the public network. Here you can also add, modify or remove UPNP item.

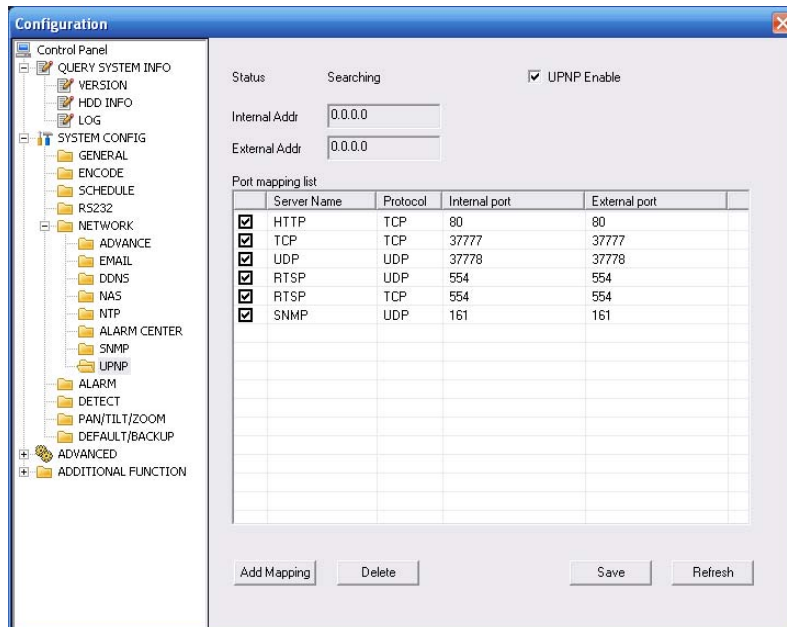

Figure 6-37 UNPN

SNMP

The SNMP interface is shown as in Figure 6-38.

SNMP is an abbreviation of Simple Network Management Protocol. It provides the basic network management frame of the network management system. The SNMP widely used in many environments. It is used in many network device, software and system.

Please refer to chapter 4.6.5.12 SNMP for detailed information.

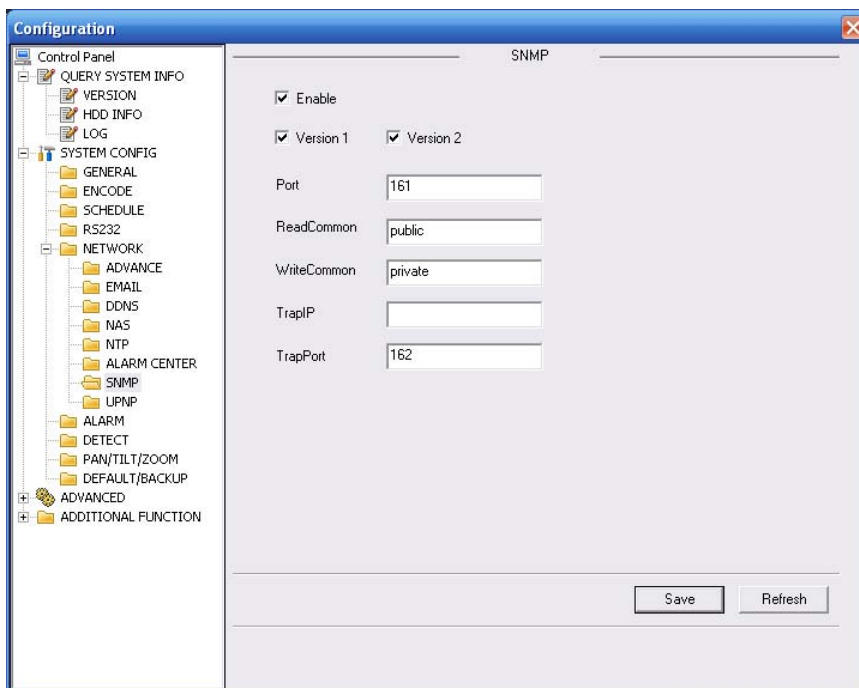

Figure 6-38 SNMP

6.4.2.6 Alarm

Alarm setup interface is shown as in Figure 6-39.

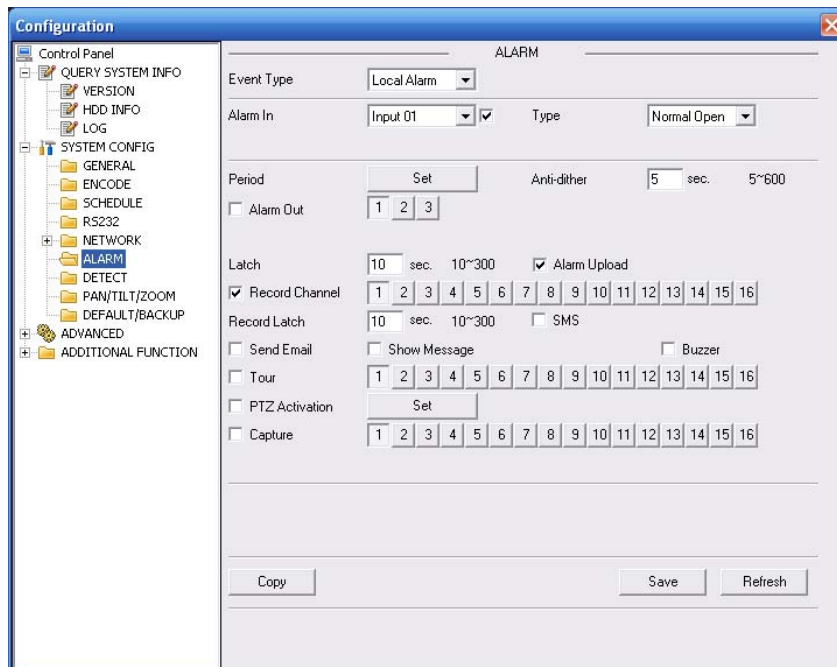

Figure 6-39 Alarm Setup

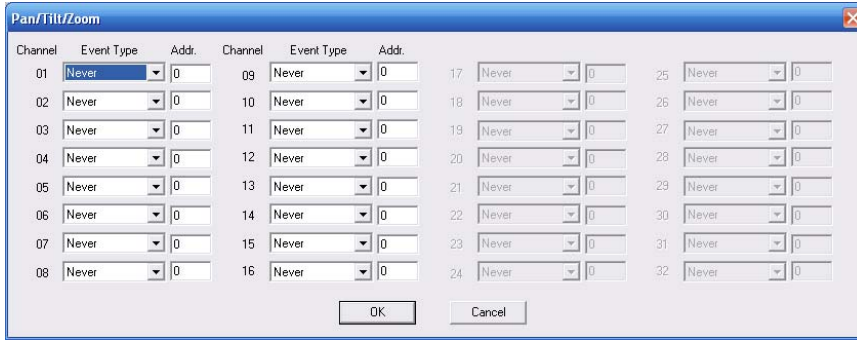

Figure 6-40 PTZ Setup

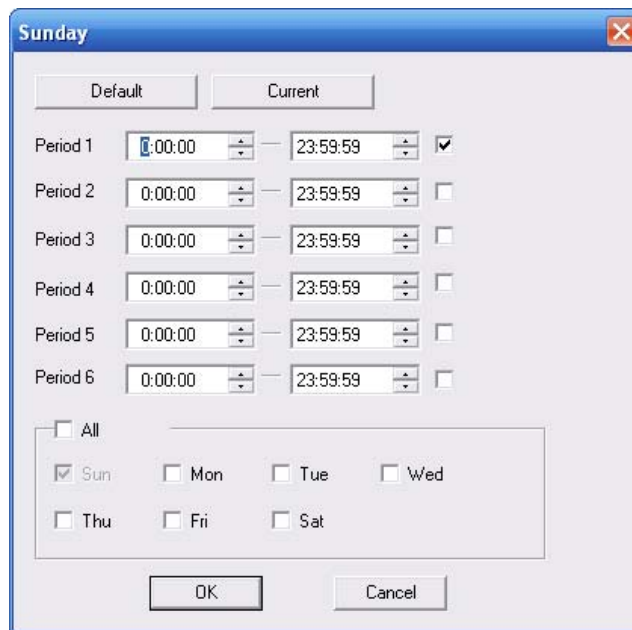

Figure 6-41

Please refer to the following sheet for detailed information.

Parameter	Function
Event Type	<p>Event type: There are four types. Local input/network input/IPC external/IPC offline alarm.</p> <ul style="list-style-type: none"> ✧ Local input alarm: The alarm signal system detects from the alarm input port. ✧ Network input alarm: It is the alarm signal from the network. ✧ IPC external alarm: It is the on-off alarm signal from the front-end device and can activate the local NVR. ✧ IPC offline alarm: Once you select this item, system can generate an alarm when the front-end IPC disconnects with the local NVR.
Alarm in	Select corresponding alarm channel.
Enable	You need to draw a circle here so that system can detect the alarm signal.

Parameter	Function
Type	There are two options: normal open and normal close. NO becomes activated in low voltage, NC becomes activated in high voltage.
Period	Alarm record function becomes activated in the specified periods. There are six periods in one day. Please draw a circle to enable corresponding period. Select date. If you do not select, current setup applies to today only. You can select all week column to apply to the whole week. Click OK button, system goes back to alarm setup interface, please click save button to exit.
Anti-dither	System only memorizes one event during the anti-dither period. The value ranges from 0 to 15s.
Relay Out	Enable alarm activation function. You need to select alarm output port so that system can activate corresponding alarm device when an alarm occurs. For 6-ch alarm output port device, the 6 th channel is the controllable +12V output.
Alarm Latch	System can delay the alarm output for specified time after alarm ends. The value ranges from 10 seconds to 300 seconds.
Record Channel	System auto activates current channel to record once an alarm occurs (working with alarm activation function). Please note current device shall be in auto record mode
Record Latch	System can delay the record for specified time after an alarm ended. The value ranges from 10s to 300s.
Email	Please draw a circle to enable email function. System can send email to alert you when an alarm occurs and ends.
Screen display	After enabled, alarm info will be prompted out on the local output end. That is to say, the alarm prompt will be displayed beside the channel name on the local surveillance image.
Buzzer	Once you check the box here, the buzzer beeps when an alarm occurred.
Tour	Display the selected video in local monitor window. When alarm occurs, system can begin one-window tour for the activated record channel. Please set the tour time in the local end.
PTZ activation	Here you can set PTZ movement when alarm occurs. Such as go to preset x when there is an alarm. The PTZ configuration events include preset, tour, and pattern.
Capture	You need to input capture channel number so that system can backup snapshot file when an alarm occurs.
Copy	It is a shortcut menu button. You can copy current channel setup to one or more (all) channels.

6.4.2.1 Detect

By analyzing video image, system will boot video detection alarm when it senses the motion

signal which meets the senility standard that is previously set. See Figure 6-42.

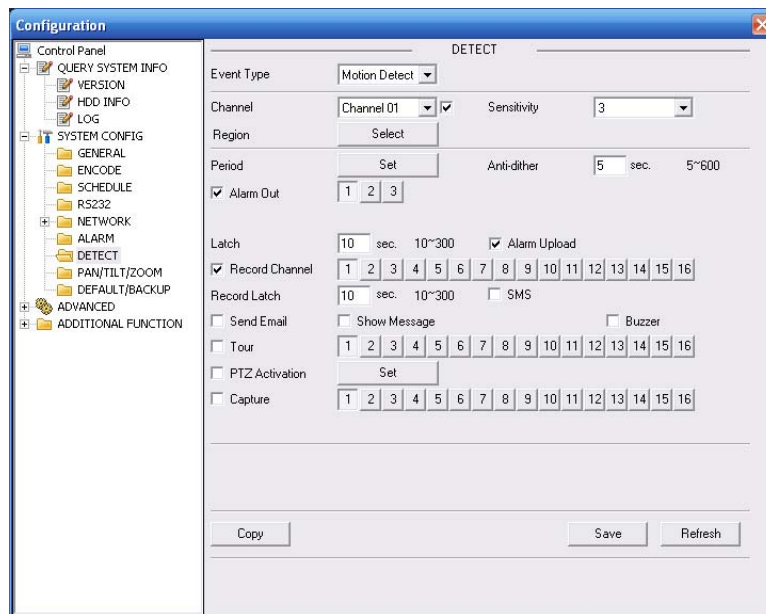

Figure 6-42 Detect

Please refer to the following sheet for detailed information.

Parameter	Function
Event type	Motion detect, video loss and video masking
Channel	Select a channel from the dropdown list to set motion detect, video loss and video masking function.
Sensitivity	System supports 6 levels. The sixth level has the highest sensitivity.
Enable button	Check the box to enable this function.
Region	There are PAL22X18/NTSC22X15 small zones. Blue area is the detection zone. Right click to view in full screen, click OK before exit to save the setup.
Period	Here you can set for business day and non-business day.
Anti-dither	Range: 0~600
Alarm output: s.	when an alarm occurred, system enables peripheral alarm device
Record channel	Select the recording channel (Multiple choices). This channel will be activated to record when an alarm occurs.
Send email	System can send out email to alert you when an alarm occurs.
Tour	Here you can enable tour function when an alarm occurs.
PTZ activation	Here you can set PTZ movement when an alarm occurs. Such as go to preset, tour & pattern when there is an alarm.
Capture	You need to input capture channel number so that system can backup snapshot file when an alarm occurs.

6.4.2.2 PTZ

PTZ interface is shown as in Figure 6-43

Please note, before operation please make sure you have set speed dome address and the NVR and speed dome connection is OK.

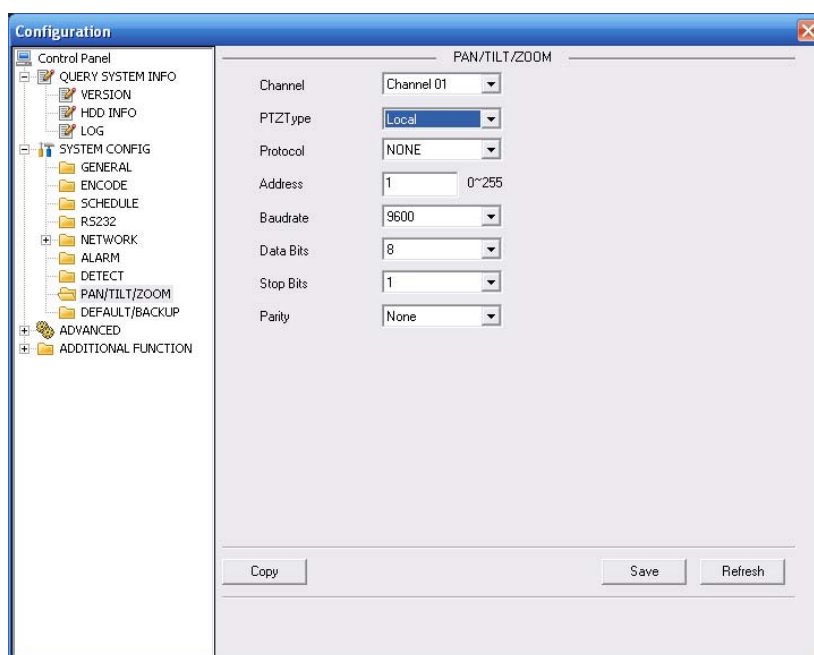

Figure 6-43 PTZ

Please refer to the following sheet for detailed information.

Parameter	Function
Channel	You can select monitor channel from the dropdown list. .
Protocol	Select the corresponding dome protocol.(such as PELCOD)
Address	Set corresponding dome address. Default value is 1. Please note your setup here shall comply with your dome address; otherwise you can not control the speed dome.
Baud Rate	Select the dome baud rate. Default setup is 115200.
Data Bit	Default setup is 8. Please set according to the speed dome dial switch setup.
Stop bit	Default setup is 1. Please set according to the speed dome dial switch setup.
Parity	Default setup is none. Please set according to the speed dome dial switch setup.

6.4.2.3 Default & Backup

Default: Restore factory default setup. You can select corresponding items.

Backup: Export current configuration to local PC or import configuration from current PC.

Please refer to Figure 6-44.

Please note system can not restore some information such as network IP address.

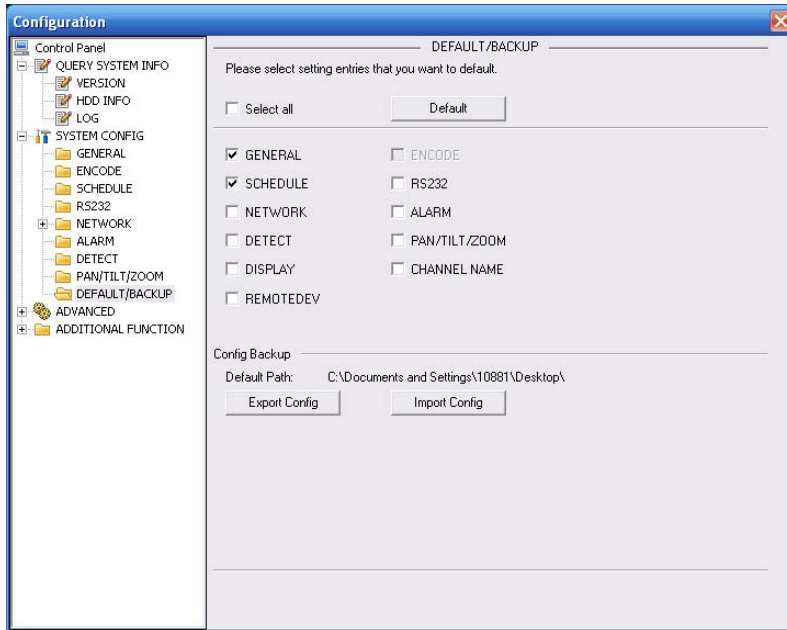

Figure 6-44 Default and Backup

Please refer to the following sheet for detailed information.

Parameter	Function
Select All	Restore factory default setup.
Export Configuration	Export system configuration to local PC.
Import Configuration	Import configuration from PC to the system.

6.4.3 Advanced

6.4.3.1 HDD Management

Please select the storage device first and then you can see the items on your right become valid. You can check the corresponding item here. See Figure 6-45.

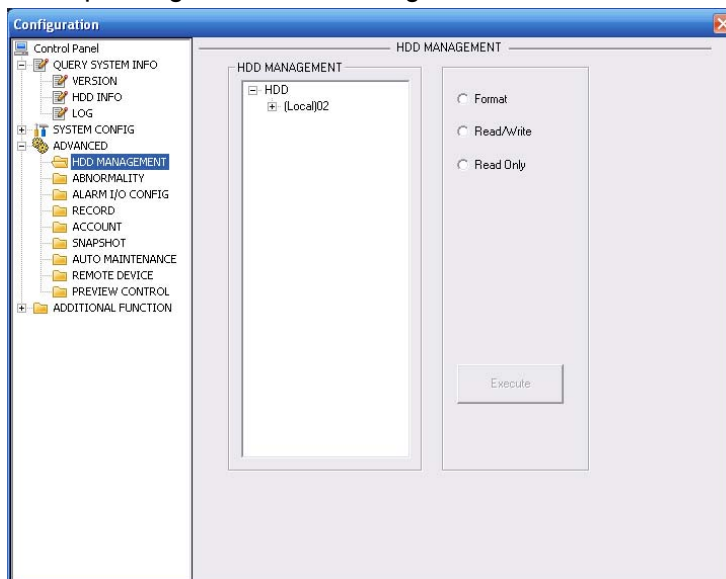

Figure 6-45 HDD Management

Please refer to the following sheet for detailed information.

Parameter	Function
Format	Clear data in the HDD.
Read/write	Set current HDD as read/write
Read only	Set current HDD as read.
Redundant	Set current HDD as redundant HDD.
Recover	Fix the HDD error. Right now the device does not support this function.

6.4.3.2 Abnormity

The interface is shown as in below. See Figure 6-46 and Figure 6-47.

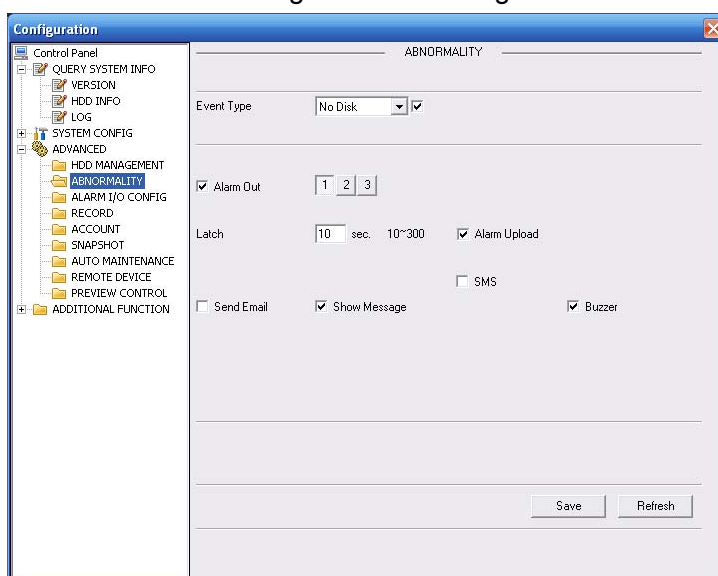

Figure 6-46 Abnormity -1

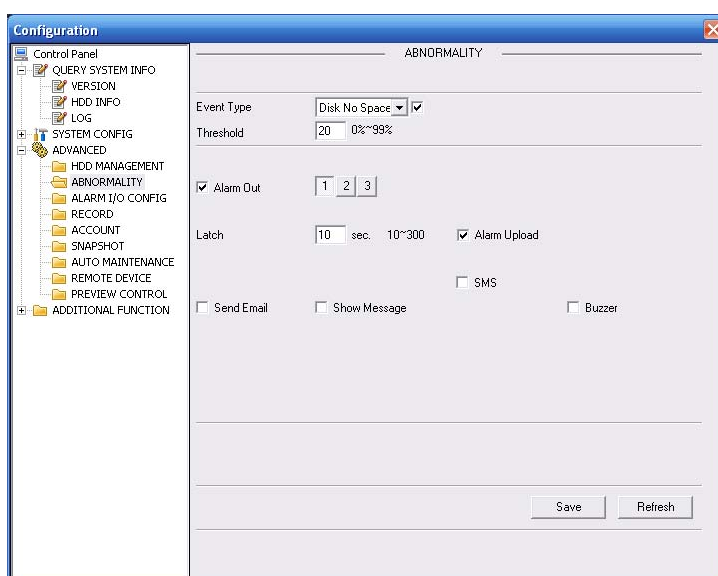

Figure 6-47 Abnormity -2

Please refer to the following sheet for detailed information.

Parameter	Function
Event Type	The abnormal events include: no disk, no space, disk error, offline, IP conflict. You need to draw a circle to enable this function. Threshold: It refers to the HDD free space threshold.
Normal Out	The corresponding alarm output channel when an alarm occurs. The alarm output channel may vary. The interface here is for reference only.
Latch	The alarm output can delay for the specified time after alarm stops. The value ranges from 10s to 300s.
Record channel	After you selected the disk connection option, once the device is offline, the activated channel can begin alarm record.
Record latch	System can delay the record for specified time after alarm ended. The value ranges from 10s to 300s.
SMS	If you check the box here, system can send out a message to the specified mobile phone when an alarm occurred.
Send email	If you enable this function, system can send out email to alarm the specified user.
Show message	Once you check the box to enable this function, system can display the alarm icon on the right of the channel name at the local end.

6.4.3.3 Alarm I/O

Here you can search alarm output status. See Figure 6-48.

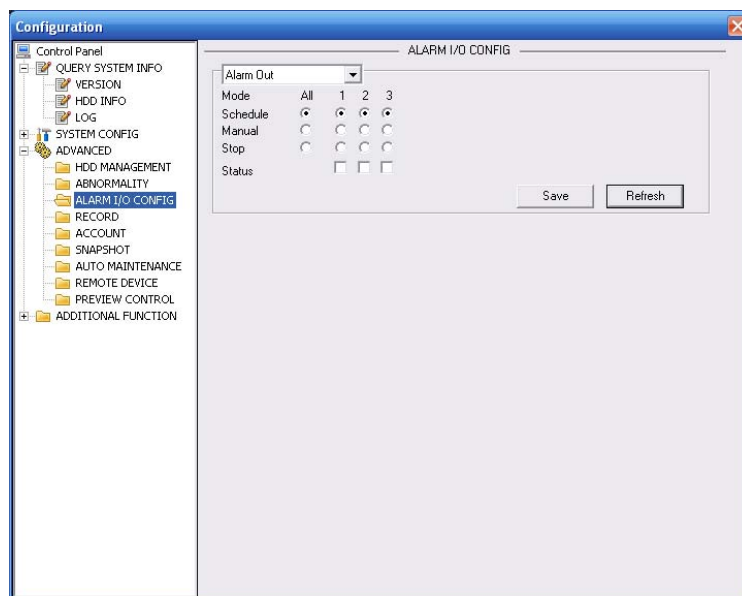

Figure 6-48 Alarm I/O Configuration

Important

The alarm output port should not be connected to high power load directly (It shall be less than 1A) to avoid high current which may result in relay damage. Please use the co contactor to realize the connection between the alarm output port and the load.

Please refer to the following sheet for detailed information.

Parameter	Function
Alarm output	The alarm output channel may vary. The interface here is for reference only. Please click the corresponding number and then click the trigger button.
Trigger	Enable/disable alarm output. Please note once you activate an alarm manually, you need to click the output channel number again and then click trigger button to disable it. Otherwise the alarm can not be cancelled.
Refresh	Search alarm output status.

6.4.3.4 Record

Record control interface is shown as in Figure 6-49.

The bit stream type includes main stream and extra stream.

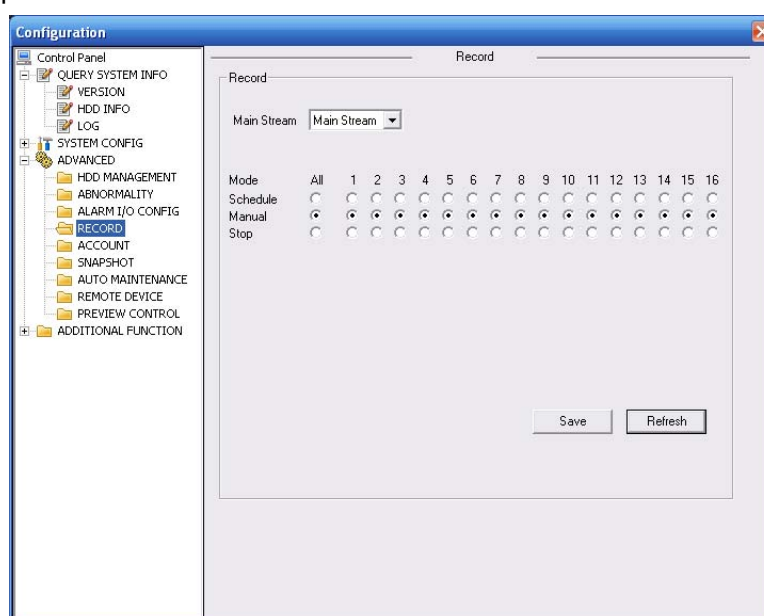

Figure 6-49 Record

Please refer to the following sheet for detailed information.

Parameter	Function
Schedule	System enables auto record function as you set in schedule setup (chapter 7.3.2.2).
Manual	Enable corresponding channel to record no matter what period applied in the record setup.
Stop	Stop current channel record no matter what period applied in the record setup.

6.4.3.5 Account

Here you can add, remove user or modify password. See Figure 6-50.

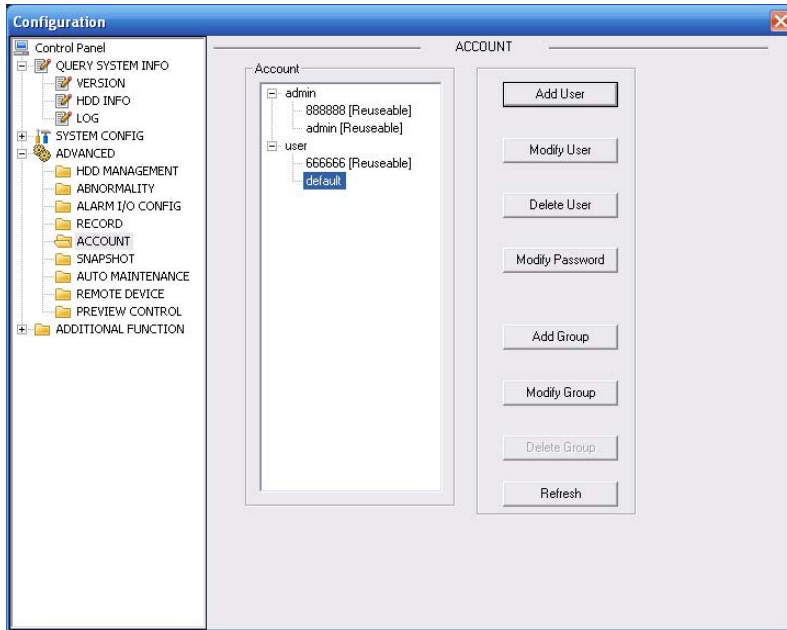

Figure 6-50 Account

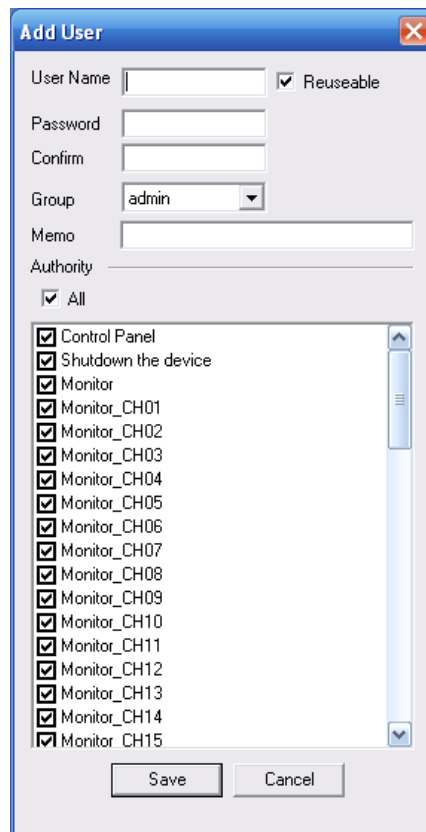

Figure 6-51 Add user

Please refer to the following sheet for detailed information.

Parameter	Function
User	Input the user name of the new established account.
Reusable	The reusable account means that this account can be used in more than one PC at the same time.

Password	Input the password of the new established account.
Confirm	Input the password of the new established account again.
Group	Select the group which the new account belongs to.
Memo	Memo about the new account
Authority/All	User can select all to entitle this account to all authorities or set authority of each item respectively.

6.4.3.6 Snapshot

Snapshot interface is shown as in Figure 6-52.

Here you can set snap mode, frequency, resolution and quality of each channel.

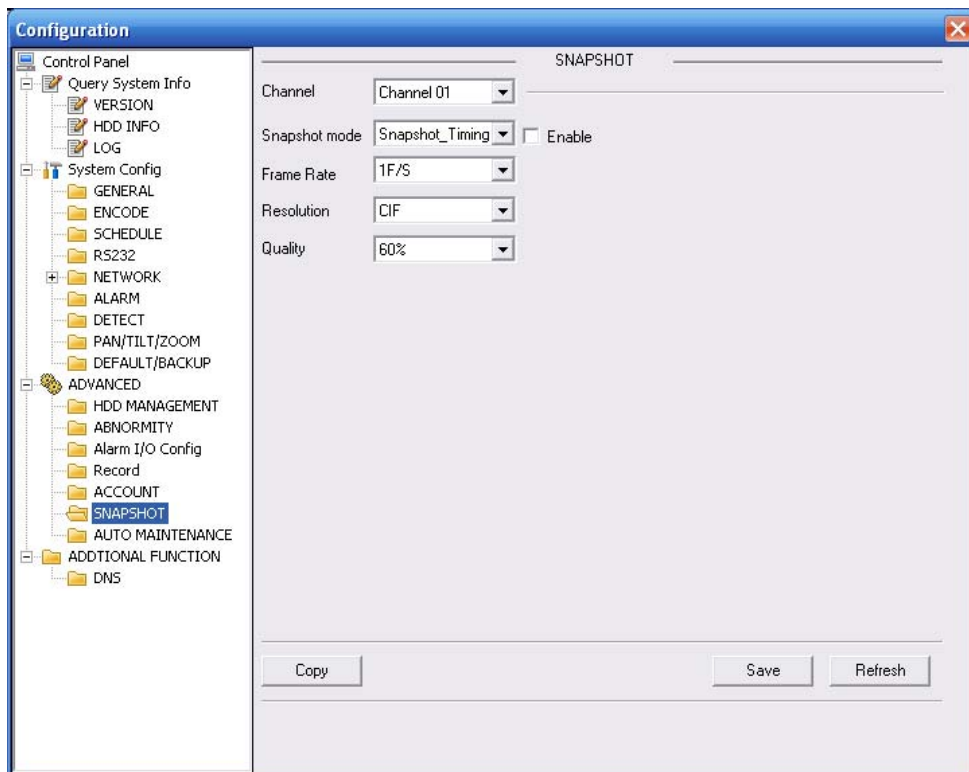

Figure 6-52

6.4.3.7 Auto Maintenance

Here you can select auto reboot and auto delete old files interval from the dropdown list. See Figure 6-53.

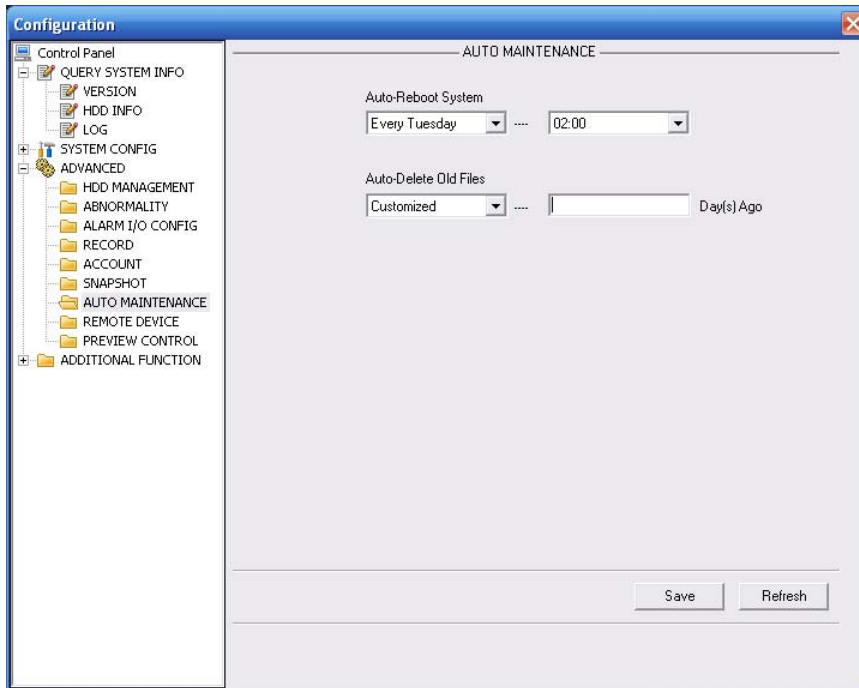

Figure 6-53 Auto Maintenance

6.4.3.8 Remote device

Remote device interface is shown as in Figure 6-54.

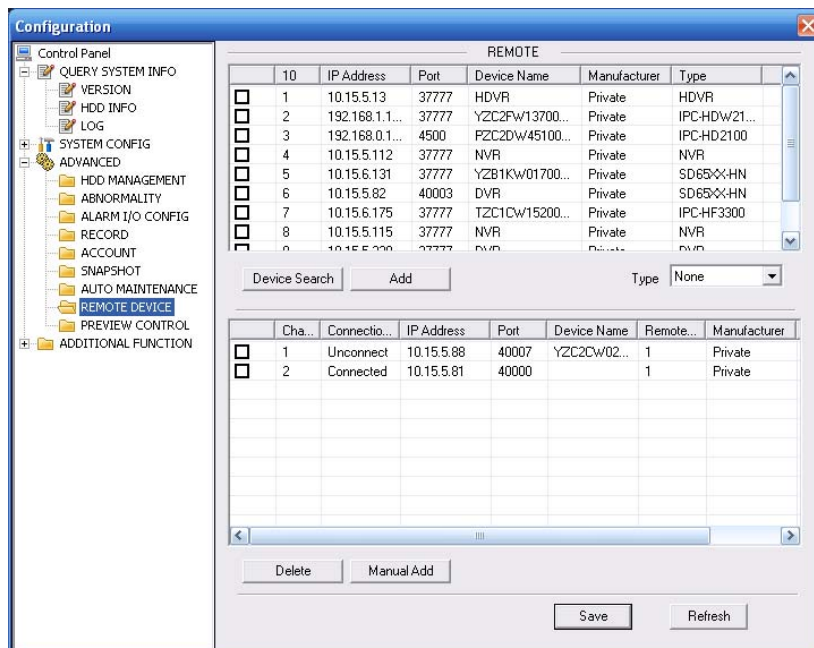

Figure 6-54 Remote device

Figure 6-55 Manual Add

Please refer to the following sheet for detailed information.

Parameter	Function
Remote device information	Here you can see searched remote device name, IP address, TCP port and manufacturer name.
Channel	Please select the local device channel number to connect to the remote device. You need to highlight the enable item to activate this function. Now you can see remote device type, IP address and etc.
Device search	Please click the Device Search button to search the all remote devices available. Please note system can only search the devices in the same segment and the device shall disable the firewall.
Type	Select remote device type here.
Manufacturer	It includes: private, Panasonic, Sony, dynacolor AXIS, arecont, Samsung, Onvif, custom and etc. For the custom mode, you can just input URL, user name, password to view the video. There are two modes: TCP (default),UDP.
IP address, port, remote channel.	Please input remote device IP address, port number, remote device channel number and account manually.
User/password	Please input account to login the remote device.
Manual add	Click the Manual add button, you can see an interface shown as in Figure 6-55. You can input remote device information manually.

6.4.3.9 Preview Control

Here you can set preview mode: 1/4/8/9/16-window. See Figure 6-56.

For 16-channel series product, the preview channel ranges from channel 1 to channel 16.

For 32-channel series product, the preview channel ranges from channel 1 to channel 32.

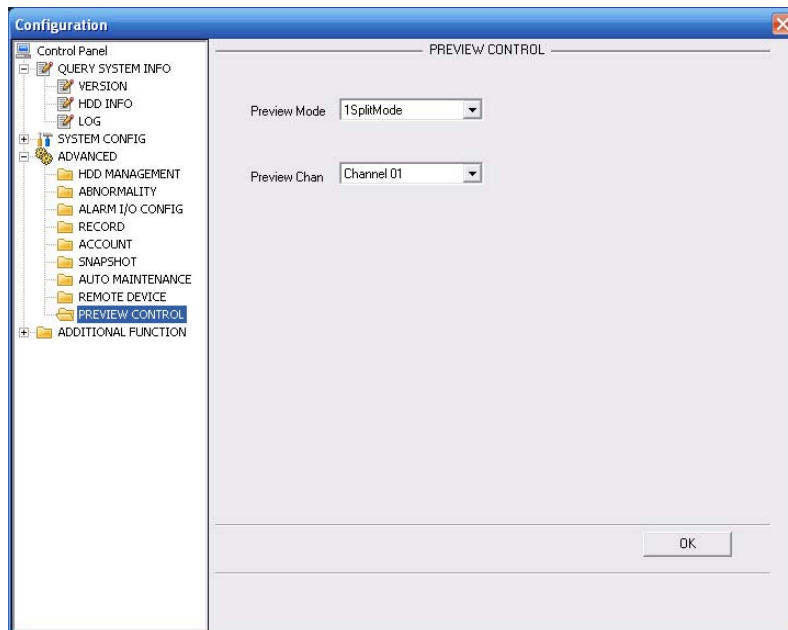

Figure 6-56 Preview Control

6.4.4 Additional Function

6.4.4.1 IPC Config

IPC configuration interface is shown as in Figure 6-57.

Here you can set gain, iris, brightness, contrastness, hue, saturation BLC and etc of the network camera.

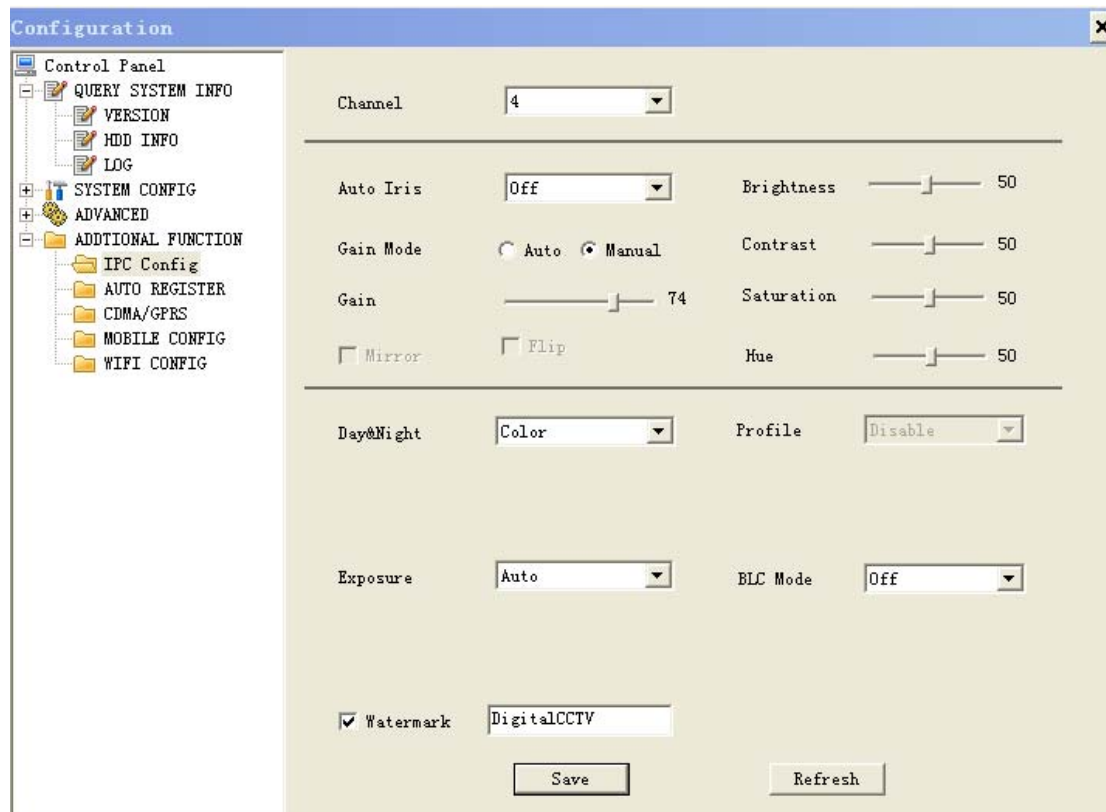

Figure 6-57 IPC Config

Please refer to the following sheet for detailed information.

Parameter	Function
Brightness	<p>It is to adjust monitor window bright. The value ranges from 0 to 100. The default value is 50.</p> <p>The larger the number, the bright the video is. When you input the value here, the bright section and the dark section of the video will be adjusted accordingly. You can use this function when the whole video is too dark or too bright. Please note the video may become hazy if the value is too high. The recommended value ranges from 40 to 60.</p>
Contrast	<p>It is to adjust monitor window contrast. The value ranges from 0 to 100. The default value is 50.</p> <p>The larger the number, the higher the contrast is. You can use this function when the whole video bright is OK but the contrast is not proper. Please note the video may become hazy if the value is too low. If this value is too high, the dark section may lack brightness while the bright section may over exposure .The recommended value ranges from 40 to 60.</p>
Saturation	<p>It is to adjust monitor window saturation. The value ranges from 0 to 100. The default value is 50.</p> <p>The larger the number, the strong the color is. This value has no effect on the general brightness of the whole video. The video color may become too strong if the value is too high. For the grey part of the video, the distortion may occur if the white balance is not accurate. Please note the video may not be attractive if the value is too low. The recommended value ranges from 40 to 60.</p>
Day/Night Mode	<p>It is to set device color and the B/W mode switch. The default setup is on.</p> <ul style="list-style-type: none"> ● Color: Device outputs the color video. ● Auto: Device auto select to output the color or the B/W video according to the device feature (The general bright of the video or there is IR light or not.) ● B/W: The device outputs the black and white video.
BLC	<p>This function can make the target clearer. It can make the details of the dark section become clear when the background is too bright.</p> <p>This function is disabled by default.</p>
Gain Mode	<p>It is to set video noise. Check Auto, system automatically sets video gain. Check Manual, you can set gain threshold, brightness and etc.</p>
Gain Adjust	<p>Gain threshold: Here is for you to set gain value. The different series product has different default values. The lower the value is, the lower the noise is. But the video brightness may become too dark under the low illumination. If the value is high, it can enhance the video brightness under the low illumination, but the video noise may become high.</p>
WB	<p>Enable white balance is to allow the camera to restore the white object. It can correct the color temperature between the indoor and outdoor environment.</p>

Mirror	It is to switch video left and right limit. This function is disabled by default.
Flip	It is to switch video up and bottom limit. This function is disabled by default. Please note the video resolution shall be 720P or lower when it is to flip 90°.
Watermark	Enable this function to check the video has been tampered with or not.

6.4.4.2 Auto register

The auto register interface is shown as in Figure 6-58.

You can set the server IP and port if you want to use the auto register function. After the device registered to the server, you can access the device after the client-end connected to the server.

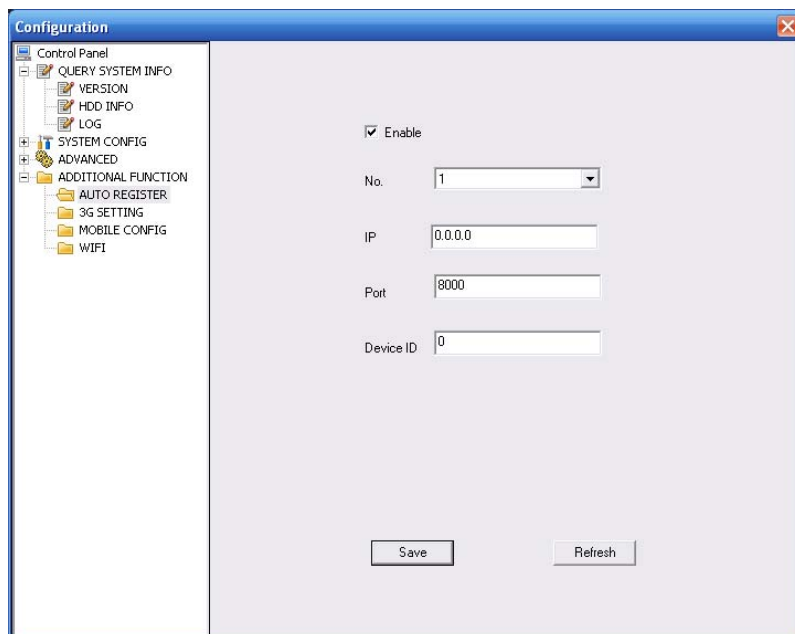

Figure 6-58 Auto register

6.4.4.3 Mobile Config

The mobile setup interface is shown as in Figure 6-59.

Here you can activate or disconnect device 3G connection such as telephone or mobile phone, or the alarm activated message No.

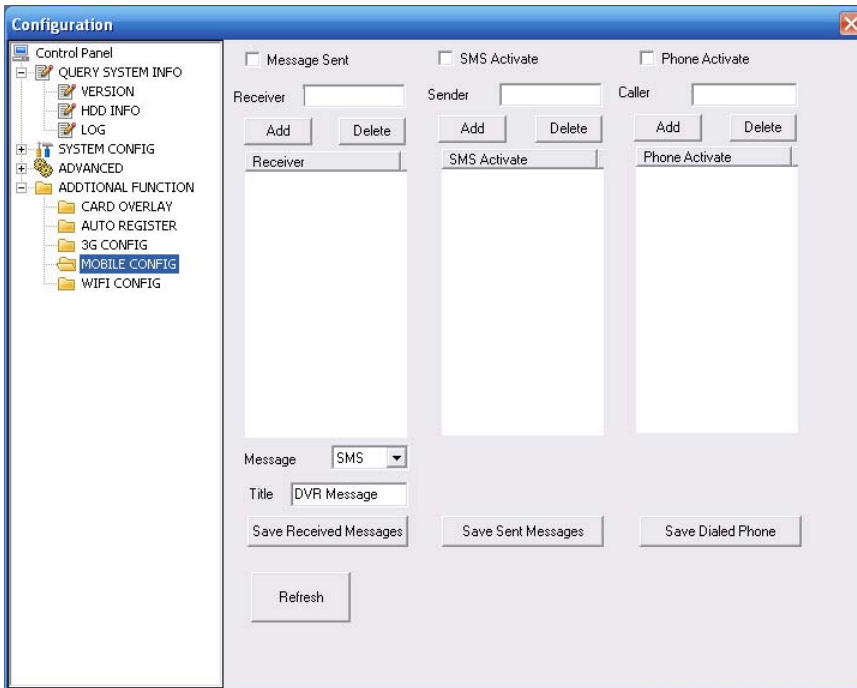

Figure 6-59 Mobile Setup

6.4.4.4 WIFI Config

The WIFI interface is shown as in Figure 6-60.

Here you can view WIFI connection status. System displays as no connection if there is no connection. You can view connection status and IP address if there is a connection. See Figure 6-61.

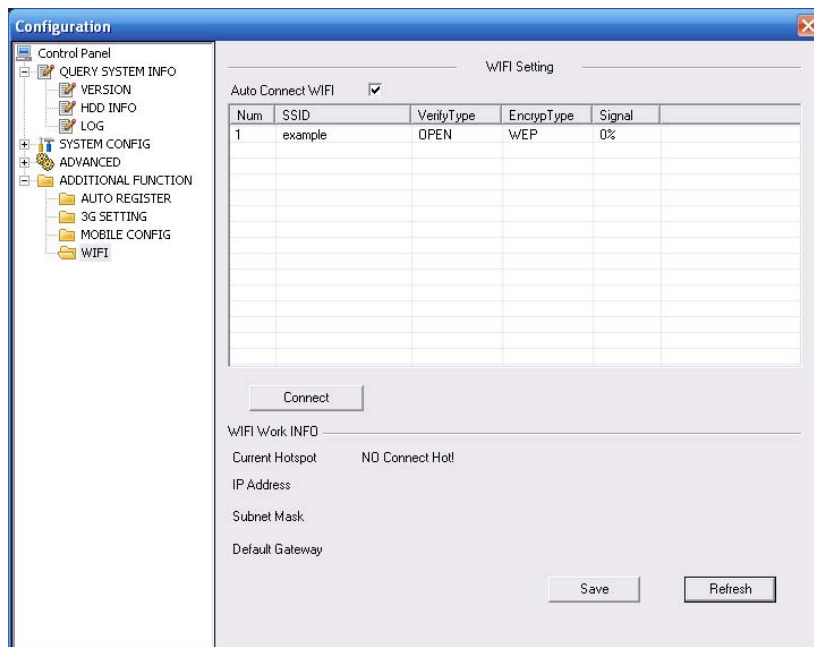

Figure 6-60 WIFI Setup



Figure 6-61

Please refer to the following sheet for detailed information.

Parameter	Function
Refresh	Search hotspot again and system can automatically add the information such as password (If there is any record of the hotspot.)
WIFI working information	Here you can view current connection status. You can view connection status and IP address if there is a connection. Otherwise system shown as there is no hotspot connection.

6.5 Search

Click search button, you can see an interface is shown as in Figure 7-60.

Please set record type, record date, window display mode and channel name.

You can click the date on the right pane to select the date. The green highlighted date is system current date and the blue highlighted date means it has record files.



Figure 6-62

Then please click search button, you can see the corresponding files in the list. See Figure 7-61.

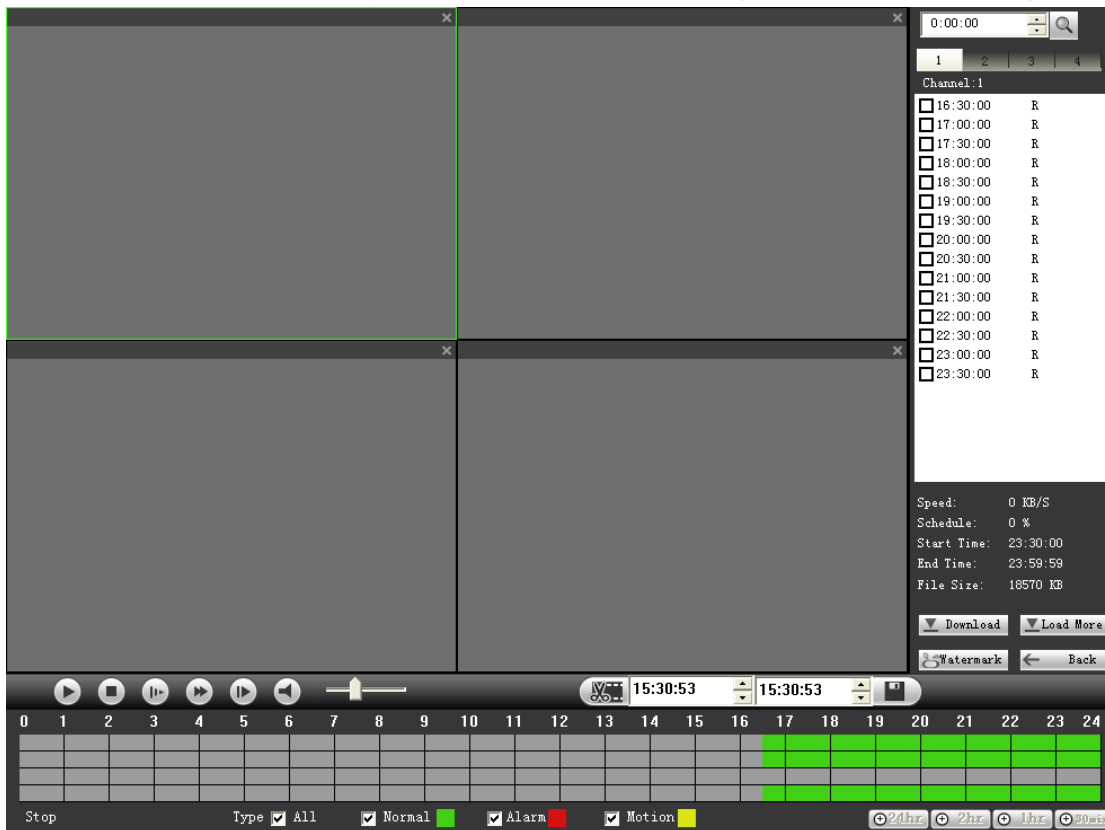

Figure 6-63

Select the file(s) you want to download and then click download button, system pops up a dialogue box shown as in Figure 7-62, then you can specify file name and path to download the file(s) to your local pc.

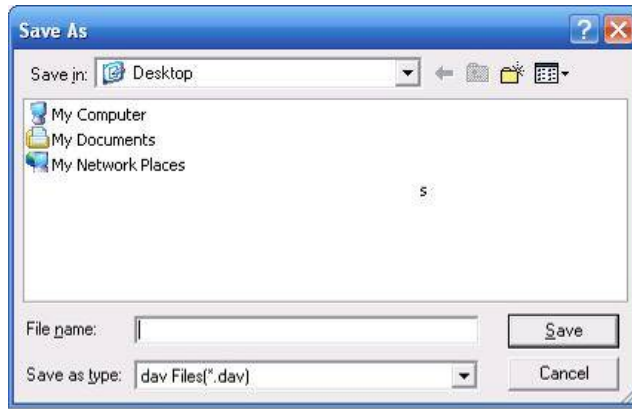

Figure 6-64

Load more

It is for you to search record or picture. You can select record channel, record type and record time to download. See Figure 6-65.

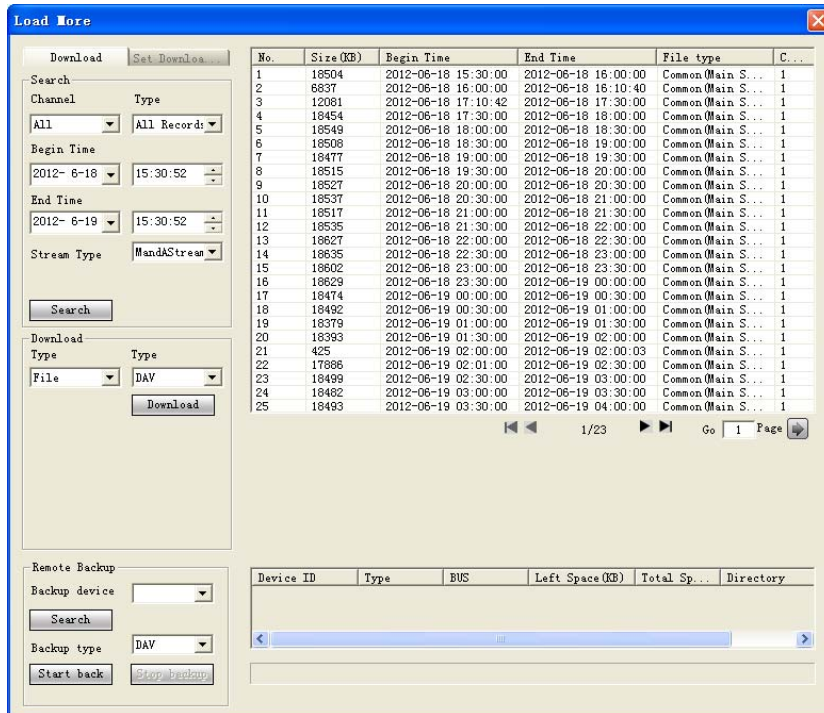

Figure 6-65

In Figure 6-65, there is a remote backup pane at the left bottom of the pane. It allows you to backup the record or picture to your local USB2.0 storage media via the Web remotely. Click the search button; you can view the available storage device. See Figure 6-65. Please select from the dropdown list and then begin the backup. Please refer to chapter 6.2.5 to set device download path.

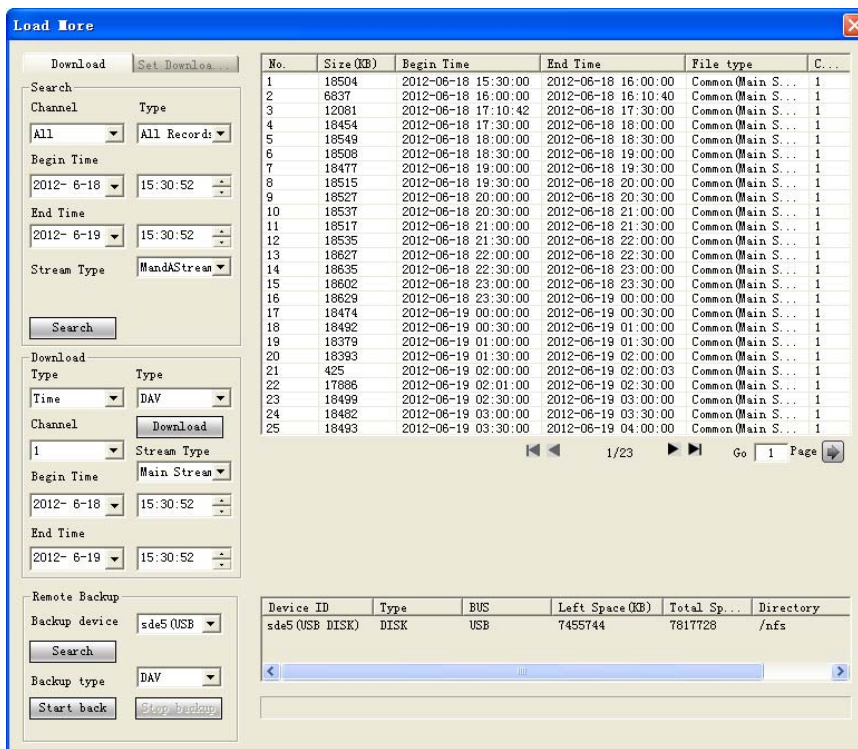

Figure 6-66

Now you can see system begins download and the download button becomes stop button. You can click it to terminate current operation.

At the bottom of the interface, there is a process bar for your reference.

6.6 Alarm

Click alarm function, you can see an interface is shown as in Figure 6-67.

Here you can set device alarm type and alarm sound setup.

When an alarm occurs, system can display the alarm information in the corresponding interface.

For motion detect, video loss, camera masking, you need to set the event in the motion detection interface. Current series product does not support this function.

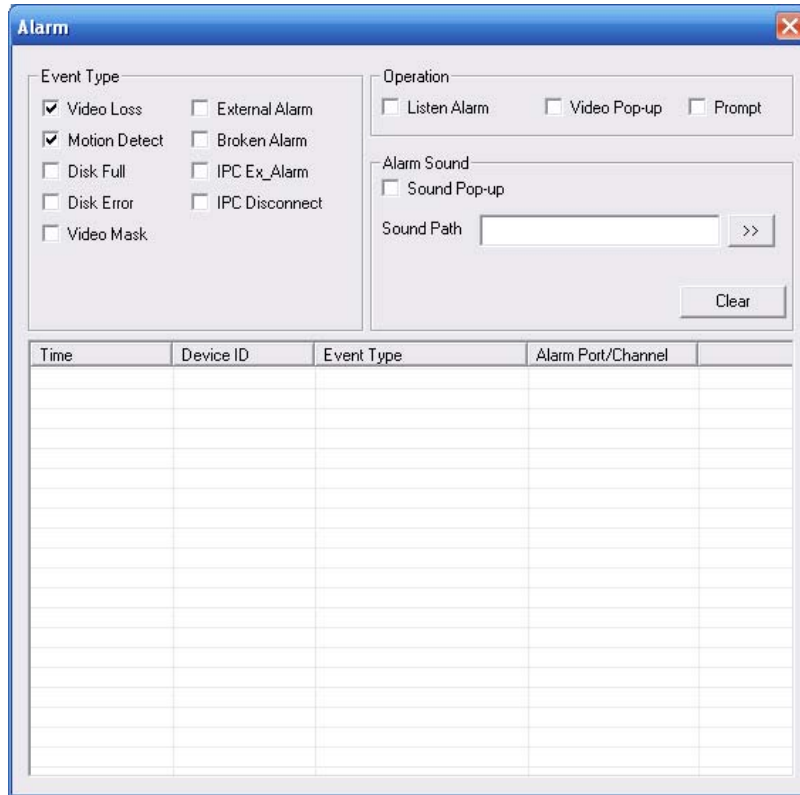

Figure 6-67 Alarm

Please refer to the following sheet for detailed information.

Type	Parameter	Function
Alarm Type	Video loss	System alarms when video loss occurs.
	Motion detection	System alarms when motion detection alarm occurs,
	Disk full	System alarms when disk is full.
	Disk error	System alarms when disk error occurs.
	Camera masking	System alarms when camera is viciously masking.
	External alarm	Alarm input device sends out an alarm.
	Offline alarm	NVR local-end offline alarm.
	IPC external alarm	It refers to the on-off alarm signal from the front-end device and can activate NVR local operation.
Operation	IPC offline alarm	System can generate an alarm when the front-end IPC disconnects with the local NVR.
	Listening alarm	System notifies web when an alarm occurs (you select from the above event type), and then web can notify user.
	Video	When an alarm occurs, system auto enables video monitor. This function only applies to video detection alarm (motion detection, video loss and camera masking). This function is not available in current device.
	Prompt	Automatically pops up alarm dialogue box.

Type	Parameter	Function
	Sound pop up	System sends out alarm sound when an alarm occurs. You can specify as you wish.
	Path	Here you can specify alarm sound file.

6.7 About

Click about button, you can view the web information. See Figure 6-68.

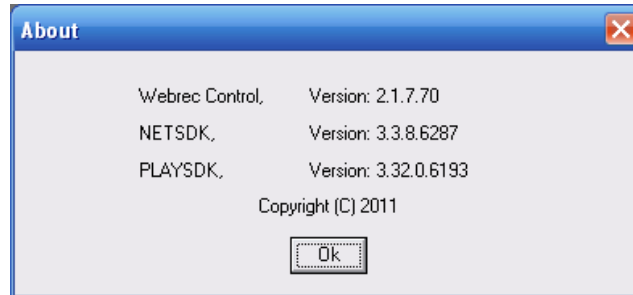

Figure 6-68 About

6.8 Log out

Click log out button, you can go back to log in interface. See Figure 6-69.

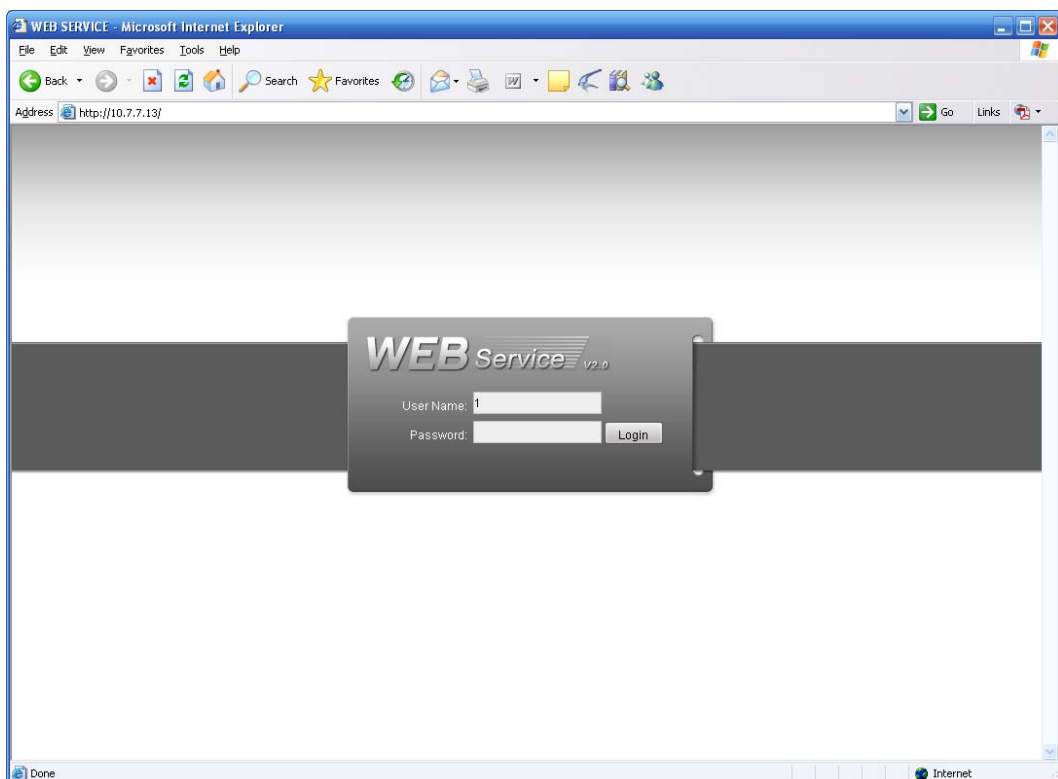

Figure 6-69 Logout

7 FAQ

1. Device can not boot up properly.

There are following possibilities:

- Input power is not correct.
- Power connection is not correct.
- Power switch button is damaged.
- Program upgrade is wrong.
- HDD malfunction or something wrong with HDD ribbon.
- Seagate DB35.1, DB35.2, SV35 or Maxtor 17-g has compatibility problem. Please upgrade to the latest version to solve this problem.
- Front panel error.
- Main board is damaged.

2. Device often automatically shuts down or stops running.

There are following possibilities:

- Input voltage is not stable or it is too low.
- HDD malfunction or something wrong with the ribbon.
- Button power is not enough.
- Front video signal is not stable.
- Working environment is too harsh, too much dust.
- Hardware malfunction.

3. System can not detect hard disk.

There are following possibilities:

- HDD is broken.
- HDD ribbon is damaged.
- HDD cable connection is loose.
- Main board SATA port is broken.

4. There is no video output whether it is one-channel, multiple-channel or all-channel output.

There are following possibilities:

- Program is not compatible. Please upgrade to the latest version.
- Brightness is 0. Please restore factory default setup.
- There is no video input signal or it is too weak.
- Check privacy mask setup or your screen saver.
- Device hardware malfunctions.

5. Real-time video color is distorted.

There are following possibilities:

- When using BNC output, NTSC and PAL setup is not correct. The real-time video becomes black and white.
- Device and monitor resistance is not compatible.
- Video transmission is too long or degrading is too huge.

- Device color or brightness setup is not correct.

6. Can not search local records.

There are following possibilities:

- HDD ribbon is damaged.
- HDD is broken.
- Upgraded program is not compatible.
- The recorded file has been overwritten.
- Record function has been disabled.

7. Video is distorted when searching local records.

There are following possibilities:

- Video quality setup is too low.
- Program read error, bit data is too small. There is mosaic in the full screen. Please restart the device to solve this problem.
- HDD data ribbon error.
- HDD malfunction.
- Device hardware malfunctions.

8. There is no audio when monitor.

There are following possibilities:

- It is not a power picker.
- It is not a power acoustics.
- Audio cable is damaged.
- Device hardware malfunctions.

9. There is audio when monitor but there is no audio when system playback.

There are following possibilities:

- Setup is not correct. Please enable audio function
- Corresponding channel has no video input. Playback is not continuous when the screen is blue.

10. Time display is not correct.

There are following possibilities:

- Setup is not correct
- Battery contact is not correct or voltage is too low.
- Crystal is broken.

11. Device can not control PTZ.

There are following possibilities:

- Front panel PTZ error
- PTZ decoder setup, connection or installation is not correct.
- Cable connection is not correct.
- PTZ setup is not correct.
- PTZ decoder and device protocol is not compatible.

- PTZ decoder and device address is not compatible.
- When there are several decoders, please add 120 Ohm between the PTZ decoder A/B cables furthest end to delete the reverberation or impedance matching. Otherwise the PTZ control is not stable.
- The distance is too far.

12. Motion detection function does not work.

There are following possibilities:

- Period setup is not correct.
- Motion detection zone setup is not correct.
- Sensitivity is too low.
- For some versions, there is hardware limit.

13. Can not log in client-end or web.

There are following possibilities:

- For Windows 98 or Windows ME user, please update your system to Windows 2000 sp4. Or you can install client-end software of lower version. Please note right now, our device is not compatible with Windows VISTA control.
- ActiveX control has been disabled.
- No dx8.1 or higher. Please upgrade display card driver.
- Network connection error.
- Network setup error.
- Password or user name is invalid.
- Client-end is not compatible with device program.

14. There is only mosaic no video when preview or playback video file remotely.

There are following possibilities:

- Network fluency is not good.
- Client-end resources are limit.
- There is multiple-cast group setup in device. This mode can result in mosaic. Usually we do not recommend this mode.
- There is privacy mask or channel protection setup.
- Current user has no right to monitor.
- Device local video output quality is not good.

15. Network connection is not stable.

There are following possibilities:

- Network is not stable.
- IP address conflict.
- MAC address conflict.
- PC or device network card is not good.

16. Burn error /USB2.0 back error.

There are following possibilities:

- Burner and device are in the same data cable.

- System uses too much CPU resources. Please stop record first and then begin backup.
- Data amount exceeds backup device capacity. It may result in burner error.
- Backup device is not compatible.
- Backup device is damaged.

17. Keyboard can not control device.

There are following possibilities:

- Device serial port setup is not correct
- Address is not correct
- When there are several switchers, power supply is not enough.
- Transmission distance is too far.

18. Alarm signal can not been disarmed.

There are following possibilities:

- Alarm setup is not correct.
- Alarm output has been open manually.
- Input device error or connection is not correct.
- Some program versions may have this problem. Please upgrade your system.

19. Alarm function is null.

There are following possibilities:

- Alarm setup is not correct.
- Alarm cable connection is not correct.
- Alarm input signal is not correct.
- There are two loops connect to one alarm device.

20. Remote control does not work.

There are following possibilities:

- Remote control address is not correct.
- Distance is too far or control angle is too small.
- Remote control battery power is low.
- Remote control is damaged or device front panel is damaged.

21. Record storage period is not enough.

There are following possibilities:

- Camera quality is too low. Lens is dirty. Camera is installed against the light. Camera aperture setup is not correct.
- HDD capacity is not enough.
- HDD is damaged.

22. Can not playback the downloaded file.

There are following possibilities:

- There is no media player.
- No DXB8.1 or higher graphic acceleration software.

- There is no DivX503Bundle.exe control when you play the file transformed to AVI via media player.
- No DivX503Bundle.exe or ffdshow-2004 1012 .exe in Windows XP OS.

23. I forgot local menu operation password or network password

Please contact your local service engineer or our sales engineer for help. We can guide you to solve this problem.

24. There is no video. The screen is in black.

There are following possibilities:

- IPC IP address is not right.
- IPC port number is not right.
- IPC account (user name/password) is not right.

25. The displayed video is not complete.

Please check current resolution setup. If the current setup is 1920*1080, then you need to set the monitor resolution as 1920*1080.

26. There is no HDMI output.

There are following possibilities:

- Displayer is not in HDMI mode.
- HDMI cable connection is not right.

27. The video is not fluent when I view in multiple-channel mode from the client-end.

There are following possibilities:

- The network bandwidth is not sufficient. The multiple-channel monitor operation needs at least 100M or higher.
- Your PC resources are not sufficient. For 16-ch remote monitor operation, the PC shall have the following environment: Quad Core, 2G or higher memory, independent displayer, display card memory 256M or higher.

Daily Maintenance

- Please use the brush to clean the board, socket connector and the chassis regularly.
- The device shall be soundly earthed in case there is audio/video disturbance. Keep the device away from the static voltage or induced voltage.
- Please unplug the power cable when you remove the audio/video signal cable, RS232 or RS485 cable.
- Always shut down the device properly. Please press the power button in the front pane for at least three seconds to shut down the device. Otherwise it may result in HDD malfunction.
- Please make sure the device is away from the direct sunlight or other heating sources. Please keep the sound ventilation.
- Please check and maintain the device regularly.

8 Appendix A HDD Capacity Calculation

Calculate total capacity needed by each device according to video recording (video recording type and video file storage time).

Step 1: According to Formula (1) to calculate storage capacity q_i that is the capacity of each channel needed for each hour, unit Mbyte.

$$q_i = d_i \div 8 \times 3600 \div 1024 \quad (1)$$

In the formula: d_i means the bit rate, unit Kbit/s

Step 2: After video time requirement is confirmed, according to Formula (2) to calculate the storage capacity m_i , which is storage of each channel needed unit Mbyte.

$$m_i = q_i \times h_i \times D_i \quad (2)$$

In the formula:

h_i means the recording time for each day (hour)

D_i means number of days for which the video shall be kept

Step 3: According to Formula (3) to calculate total capacity (accumulation) q_T that is needed for all channels in the device during **scheduled video recording**.

$$q_T = \sum_{i=1}^c m_i \quad (3)$$

In the formula: c means total number of channels in one device

Step 4: According to Formula (4) to calculate total capacity (accumulation) q_T that is needed for all channels in device during **alarm video recording (including motion detection)**.

$$q_T = \sum_{i=1}^c m_i \times a\% \quad (4)$$

In the formula: $a\%$ means alarm occurrence rate

9 Appendix B Compatible SATA HDD

Manufacturer	Series	Model	Capacity	Port Mode
Seagate	Seagate SV35.1	ST3250824SV	250G	SATA
Seagate	Seagate SV35.1	ST3500641SV	500G	SATA
Seagate	Seagate SV35.2	ST3250820SV	250G	SATA
Seagate	Seagate SV35.2	ST3320620SV	320G	SATA
Seagate	Seagate SV35.2	ST3500630SV	500G	SATA
Seagate	Seagate SV35.2	ST3750640SV	750G	SATA
Seagate	Seagate SV35.3	ST3250310SV	250G	SATA
Seagate	Seagate SV35.3	ST3500320SV	500G	SATA
Seagate	Seagate SV35.3	ST3750330SV	750G	SATA
Seagate	Seagate SV35.3	ST31000340SV	1T	SATA
Seagate	Seagate SV35.4	ST3320410SV	320G	SATA
Seagate	Seagate SV35.4	ST3250311SV	250G	SATA
Seagate	Seagate SV35.5	ST3500410SV	500G	SATA
Seagate	Seagate SV35.5	ST3500411SV	500G	SATA
Seagate	Seagate SV35.5	ST31000525SV	1T	SATA
Seagate	Seagate SV35.5	ST31000526SV	1T	SATA
Seagate	Seagate SV35.5	ST1000VX000	1T	SATA
Seagate	Seagate SV35.5	ST2000VX003	2T	SATA
Seagate	Seagate SV35.5	ST2000VX002	2T	SATA
Seagate	Seagate SV35.5	ST2000VX000	2T	SATA
Seagate	Seagate SV35.5	ST3000VX000	3T	SATA
Seagate	Seagate Pipeline HD	ST3320410CS	320G	SATA
Seagate	Seagate Pipeline HD	ST3320310CS	320G	SATA
Seagate	Seagate Pipeline HD	ST3500422CS	500G	SATA
Seagate	Seagate Pipeline HD	ST3500321CS	500G	SATA
Seagate	Seagate Pipeline HD2	ST3250412CS	250G	SATA
Seagate	Seagate Pipeline	ST3320311CS	250G	SATA

	HD2			
Seagate	Seagate Pipeline HD2	ST3500414CS	500G	SATA
Seagate	Seagate Pipeline HD2	ST3500312CS	500G	SATA
Seagate	Seagate Pipeline HD2	ST31000424CS	1T	SATA
Seagate	Seagate Pipeline HD2	ST31000322CS	1T	SATA
Seagate	Seagate Pipeline HD2	ST1000VM002	1T	SATA
Seagate	Seagate Pipeline HD2	ST1500VM002		
Seagate	Seagate Pipeline HD2	ST2000VM002	2T	SATA
Seagate	Seagate Pipeline HD2	ST2000VM003	2T	SATA
Seagate	Seagate Constellation ES	ST3500514NS	500G	SATA
Seagate	Seagate Constellation ES	ST31000524NS	1T	SATA
Seagate	Seagate Constellation ES	ST32000644NS	2T	SATA
Seagate	Seagate Constellation ES	ST2000NM0011	2T	SATA
Seagate	Seagate Constellation ES	ST1000NM0011	1T	SATA
Seagate	Seagate Constellation ES	ST500NM0011	500G	SATA
Seagate	Seagate Constellation ES	ST2000NM0031	2T	SATA
Seagate	Seagate Constellation ES	ST1000NM0031	1T	SATA
Seagate	Seagate Constellation ES	ST500NM0031	500G	SATA
Seagate	Seagate Constellation ES	ST2000NM0051	2T	SATA
Seagate	Seagate	ST1000NM0051	1T	SATA

	Constellation ES			
Seagate	Seagate Constellation ES	ST500NM0051	500G	SATA
Seagate	Seagate Constellation ES.2	ST33000650NS	3T	SATA
Seagate	Seagate Constellation ES.2	ST32000645NS	2T	SATA
Seagate	Seagate Constellation ES.2	ST33000651NS	3T	SATA
Seagate	Seagate Constellation ES.2	ST32000646NS	2T	SATA
Seagate	Seagate Constellation ES.2	ST33000652NS	3T	SATA
Seagate	Seagate Constellation ES.2	ST32000647NS	2T	SATA
Western Digital	Caviar SE	WD3200JD	320G	SATA
Western Digital	Caviar SE	WD3000JD	300G	SATA
Western Digital	Caviar SE	WD2500JS	250G	SATA
Western Digital	Caviar SE16	WD7500KS	750G	SATA
Western Digital	Caviar SE16	WD5000KS	500G	SATA
Western Digital	Caviar SE16	WD4000KD	400G	SATA
Western Digital	Caviar SE16	WD3200KS	320G	SATA
Western Digital	Caviar SE16	WD2500KS	250G	SATA
Western Digital	WD Caviar SE16	WD2500YS-01SHB0	250G	SATA
Western Digital	WD Caviar RE16	WD3200YS-01PGB0	320G	SATA
Western Digital	WD Caviar RE2	WD5000YS-01MPB0	500G	SATA
Western Digital	WD AV—AVJS	WD2500AVJS-63WDA0	500G	SATA

Digital				
Western Digital	WD AV—AVJS	WD3200AVJS-63WDA0	320G	SATA
Western Digital	WD AV—AVJS	WD5000AVJS-63YJA0	500G	SATA
Western Digital	WDAV-GP—AVCS	WD5000AVCS-63H1B1	500G	SATA
Western Digital	WDAV-GP—AVCS	WD7500AVCS-63ZLB0	750G	SATA
Western Digital	WDAV-GP—AVCS	WD3200AVCS	320G	SATA
Western Digital	WDAV-GP—AVCS	WD2500AVCS	250G	SATA
Western Digital	WDAV-GP—EVCS	WD10EVCS-63ZLB0	1T	SATA
Western Digital	WDAV-GP—EVCS	WD20EVCS-63ZLB0	2T	SATA
Western Digital	WDAV-GP—AVVS	WD3200AVVS-63L2B0	320G	SATA
Western Digital	WDAV-GP—AVVS	WD5000AVVS-63ZWB0	500G	SATA
Western Digital	WDAV-GP—AVVS	WD7500AVVS-63E1B1	750G	SATA
Western Digital	WDAV-GP—AVVS	WD7500AVVS-63E1B1	750G	SATA
Western Digital	WDAV-GP—EVVS	WD10EVVS-63E1B1	1T	SATA
Western Digital	WDAV-GP—EVDS	WD10EVDS-63N5B1	1T	SATA
Western Digital	WDAV-GP—EVDS	WD15EVDS-63V9B0	1.5T	SATA
Western Digital	WDAV-GP—EVDS	WD20EVDS-63T3B0	2T	SATA
Western Digital	WDAV-GP—AVDS	WD5000AVDS-63U7B0	500G	SATA
Western Digital	WD AV-GP	WD30EURS	3T	SATA
Western	WD AV-GP	WD25EURS	2.5T	SATA

Digital				
Western Digital	WD AV-GP	WD20EURS	2T	SATA
Western Digital	WD AV-GP	WD15EURS	1.5T	SATA
Western Digital	WD AV-GP	WD10EURS	1T	SATA
Western Digital	WD AV-GP	WD10EURX	1T	SATA
Western Digital	WD AV-GP	WD7500AURS	750G	SATA
Western Digital	WD AV-GP	WD7500AVDS	500G	SATA
Western Digital	WD AV-GP	WD500AVDS	500G	SATA
Western Digital	WD AV-GP	WD10EUCX	1T	SATA
Samsung	Samsung—HA	HA500LJ/CE	500G	SATA
Samsung	Samsung—HA	HA751LJ	750G	SATA
Samsung	Samsung—HA	HA101UJ/CE	1T	SATA
Samsung	Samsung—HD	HD502HI/CEC	500G	SATA
Samsung	Samsung—HD	HD103SI/CEC	1T	SATA
Samsung	Samsung—HD	HD154UI/CE	1.5T	SATA
Hitachi	Hitachi CinemaStar™ 5K500	HCP725050GLA380	500G	SATA
Hitachi	Hitachi CinemaStar™ 7K1000.B	HCT721050SLA360	500G	SATA
Hitachi	Hitachi CinemaStar™ 7K1000.B	HCT721075SLA360	750G	SATA
Hitachi	Hitachi CinemaStar™ 7K1000.B	HCT721010SLA360	1T	SATA
Maxtor	DiamondMax 20	STM3320820AS	320G	SATA
Maxtor	DiamondMax 20	STM3250820AS	250G	SATA

10 Appendix C Compatible USB2.0 List

Manufacturer	Model	Capacity
Sandisk	Cruzer Micro	512M
Sandisk	Cruzer Micro	1G
Sandisk	Cruzer Micro	2G
Sandisk	Cruzer Freedom	256M
Sandisk	Cruzer Freedom	512M
Sandisk	Cruzer Freedom	1G
Sandisk	Cruzer Freedom	2G
Kingston	Data Traveler II	1G
Kingston	Data Traveler II	2G
Kingston	Data Traveler	1G
Kingston	Data Traveler	2G
Maxell	USB2.0 Flash Stick	128M
Maxell	USB2.0 Flash Stick	256M
Maxell	USB2.0 Flash Stick	512M
Maxell	USB2.0 Flash Stick	1G
Maxell	USB2.0 Flash Stick	2G
Kingax	Super Stick	128M
Kingax	Super Stick	256M
Kingax	Super Stick	512M
Kingax	Super Stick	1G
Kingax	Super Stick	2G
Netac	U210	128M
Netac	U210	256M
Netac	U210	512M
Netac	U210	1G
Netac	U210	2G
Teclast	Ti Cool	128M
Teclast	Ti Cool	256M

Teclast	Ti Cool	512M
Teclast	Ti Cool	1G
Teclast	Ti Cool	2G

11 Appendix D Compatible Displayer List

Brand	Model	Dimension (Unit: inch)
BENQ (LCD)	ET-0007-TA	19-inch (wide screen)
DELL (LCD)	E178FPc	17-inch
BENQ (LCD)	Q7T4	17-inch
BENQ (LCD)	Q7T3	17-inch
LENOVO (LCD)	LXB-L17C	17-inch
SANGSUNG (LCD)	225BW	22-inch (wide screen)
LENOVO(CRT)	LXB-FD17069HB	17-inch
LENOVO(CRT)	LXB-HF769A	17-inch
LENOVO(CRT)	LX-GJ556D	17-inch
Samsung (LCD)	2494HS	24-inch
Samsung (LCD)	P2350	23-inch
Samsung (LCD)	P2250	22-inch
Samsung (LCD)	P2370G	23-inch
Samsung (LCD)	2043	20-inch
Samsung (LCD)	2243EW	22-inch
LG (LCD)	W1942SP	19-inch
LG (LCD)	W2243S	22-inch
LG (LCD)	W2343T	23-inch
BENQ (LCD)	G900HD	18.5-inch
BENQ (LCD)	G2220HD	22-inch
PHILIPS (LCD)	230E	23-inch
PHILIPS (LCD)	220CW9	23-inch
PHILIPS (LCD)	220BW9	24-inch
PHILIPS (LCD)	220EW9	25-inch

Appendix H Toxic or Hazardous Materials or Elements

Component Name	Toxic or Hazardous Materials or Elements					
	Pb	Hg	Cd	Cr VI	PBB	PBDE
Sheet Metal(Case)	○	○	○	○	○	○
Plastic Parts (Panel)	○	○	○	○	○	○
Circuit Board	○	○	○	○	○	○
Fastener	○	○	○	○	○	○
Wire and Cable/Ac Adapter	○	○	○	○	○	○
Packing Material	○	○	○	○	○	○
Accessories	○	○	○	○	○	○

Note

O: Indicates that the concentration of the hazardous substance in all homogeneous materials in the parts is below the relevant threshold of the SJ/T11363-2006 standard.

X: Indicates that the concentration of the hazardous substance of at least one of all homogeneous materials in the parts is above the relevant threshold of the SJ/T11363-2006 standard. During the environmental-friendly use period (EFUP) period, the toxic or hazardous substance or elements contained in products will not leak or mutate so that the use of these (substances or elements) will not result in any severe environmental pollution, any bodily injury or damage to any assets. The consumer is not authorized to process such kind of substances or elements, please return to the corresponding local authorities to process according to your local government statutes.

Note

- **This manual is for reference only. Slight difference may be found in the user interface.**
- **All the designs and software here are subject to change without prior written notice.**
- **All trademarks and registered trademarks are the properties of their respective owners.**
- **If there is any uncertainty or controversy, please refer to the final explanation of us.**
- **Please visit our website or contact your local service engineer for more information.**